

## Cover Delivery Report

<b>Title of the Deliverable:</b>	<b>Report with scenario's and schemes of proven NRR techniques</b>
<b>WP Title and Number:</b>	<b>WP3, D.3.2</b>
<b>Date of completion:</b>	<b>31 January 2020 (revised 28 February 2021)</b>
<b>First Author:</b>	<b>Marieke Verbeke</b>
<b>Co-author(s):</b>	<b>Kimo Van Dijk, Claudio Brienza</b>
<b>Name of the responsible WP Leader:</b>	<b>Marieke Verbeke</b>
<b>Date of approval by the Coordinator</b>	<b>31 January 2020 (revised 28 February 2021)</b>

The research was undertaken as part of the project called 'SYSTEMIC: Systemic large scale eco-innovation to advance circular economy and mineral recovery from organic waste in Europe.  
<https://systemicproject.eu/>

This report has been submitted to the EC for approval and as such it is still to be considered as draft.

*This project has received funding from the European Union's H2020 research and innovation programme under the grant agreement No: 730400. SYSTEMIC started 1 June 2017 and will continue for 4 years.*

## Scenario's and schemes of proven nutrient recovery and reuse techniques



Marieke Verbeke

Claudio Brienza, Kimo Van Dijk

Vlaams Coördinatiecentrum voor  
Mestverwerking, Bruges, Belgium

Document type: Public Report

Deliverable 3.2

This report has been submitted to the EC  
for approval and as such it is still to be  
considered as draft.

## History of changes

<b>Date</b>	<b>Version</b>	<b>Changes</b>	<b>Page</b>
31 May 2018	1	(confidential intermediate report)	
21 January 2020	2	(final public report)	
28 February 2021	3	Preface and summary have been updated	1-3
		Chapter 1 Methodology has been updated and 1.5 Determining cost-efficiency of a technology has been added.	4-10
		Chapter 2 Results has been extended with more data. For each technology, subchapters on Technology description, Recovery efficiency, Energy requirements, Storage capacity and Costs were added.	10-110
		Chapter 3 Discussion and 4 Expected impact have been added	110-114
		Section 3.1 Biological treatment as pre-treatment or polishing step has been removed and constructed wetlands, did not comply with the criteria (described on page 7)	
		ANNEX I: References from the SYSTEMIC database, has been removed because the complete database with all its references is available on the SYSTEMIC website ( <a href="https://systemicproject.eu/business-development-package/">https://systemicproject.eu/business-development-package/</a> )	
		ANNEX II, has therefor become ANNEX I	114

# Content

---

List of abbreviations.....	1
Preface .....	1
Summary .....	3
1 Methodology .....	4
1.1 Targeted information .....	4
1.2 Selection criteria and sources.....	5
1.3 Structure of the database .....	6
1.4 Collected data points .....	7
1.5 Determining cost-efficiency of a technology.....	7
2 Results .....	10
2.1 Feedstock types and digestate composition .....	10
2.2 Selected technologies .....	10
2.2.1 Liquid-solids separation .....	11
2.2.2 Ammonia stripping-scrubbing .....	45
2.2.3 Membrane technologies .....	60
2.2.4 Ion exchange .....	72
2.2.5 Evaporation .....	79
2.2.6 Thermal drying.....	90
2.2.7 Biothermal drying/composting .....	95
2.2.8 Phosphorus precipitation.....	97
2.2.9 Phosphorus solubilisation and precipitation .....	99
3. Discussion and conclusions.....	110
3.1 Technologies and cascades to be included in the NUTRICAS Tool.....	110
3.2 Cost-efficiency of the technology cascades.....	111
4 Expected impact .....	112
I. Annex I .....	114
References .....	122

# List of abbreviations

AD: anaerobic digestion  
AP: Associated Plants  
BDP: Business Development Package  
C: concentrate  
CaP: calcium phosphate  
CBA: cost-benefit analysis  
CHP: combined heat and power engine  
DAF: Dissolved Air Flotation  
DC: decanter centrifuge  
DMsol: soluble dry matter  
DMsus: suspended dry matter  
GZV: Groot Zevert Vergisting  
Inorg-P: inorganic phosphorus  
Kt: kiloton  
LF: liquid fraction  
NH<sub>4</sub>-N: ammonium nitrogen  
NRR: nutrient recovery and reuse  
OL: Outreach Locations  
OM: organic matter  
Org-N: organic nitrogen  
Org-P: organic phosphorus  
RePeat: Recovery of P to eat  
SE: separation efficiency  
SI: separation index  
SF: solid fraction  
TAN: Total ammonia nitrogen  
Total K : total potassium  
Total N: total nitrogen  
Total P: total phosphorus

# Preface

This study was carried out and published as a part of the European demonstration project SYSTEMIC funded by the H2020 programme (project number 730400). The project SYSTEMIC focuses at five large scale biogas plants where innovative nutrient recovery processing techniques were implemented and monitored. One of the tasks within the SYSTEMIC project is to **develop a business development package (BDP) to support decision making for implementation of the innovative business cases in Europe.**

This public report presents a list of available full-scale proven and cost-effective nutrient recovery and reuse technologies (NRR) for digestate and related flows. It will provide information to existing and future biogas plants to explore the possibilities and barriers of implementing NRR on digestate.

The selection is based on technologies implemented at the Demo Plants, Outreach Locations and Associated Plants and AP, under the assumption that they are cost-effective if they are implemented at full scale. To further prove their cost-effectiveness, data from the OL and AP, business case evaluation of the Demo plants (WP2) and literature has been used to make an estimation of the investment costs and operational costs.

Additionally, for each technique ranges of separation efficiencies and nutrient recovery rates are given, further supporting the maturity of the technologies. By combining different technologies, cascades (e.g. schemes, trains) can be made to obtain complete processing of a input flow into several end products and by-products.

From the technologies listed in this report (D 3.2), a final selection of 21 technology cascades was chosen, i.e. combinations of the above mentioned technologies including separation, N stripping-scrubbing, P-stripping, evaporation, drying and membrane filtration.

These cascades are operational at full-scale in SYSTEMIC biogas plants or include a variation on the pre-treatment of the digestate.

To further facilitate the exploration of these NRR cascades, the these were implemented in the NUTRICAS Tool.

This is an online tool which can perform a cost-benefit analysis and simulate a mass balance for the 21 nutrient recovery and reuse (NRR) cascades on

digestate. This will give the user a first insight to which extent a more specific and in depth assessment is worth to undertake.

The information compiled in this report will provide the background information (values) on which the calculation models of the NUTRICAS Tool are founded.

More detailed information on the calculation models and assumptions used in the NUTRICAS Tool can be found in "D3.5 NUTRICAS Manual and Tool Description", both are available at <https://systemicproject.eu/business-development-package/> from 1<sup>st</sup> April 2021.<sup>1</sup>

We would like to acknowledge the plant owners and staff of Acqua & Sole, AM-Power, BENAS-GNS, RIKA/Fridays, Groot Zevert Vergisting and contacted technology providers whom delivered information and insights on the technologies.

The authors

---

<sup>1</sup> To ensure the open access of the deliverables of the SYSTEMIC project, all public deliverables will be available, even after the end of the project, via the library of Wageningen University and Research (<https://www.wur.nl/en/Library.htm>) and also via digital platform Biorefine Cluster Europe (<https://www.biorefine.eu/>) and websites of some of the partners (<https://www.vcm-mestverwerking.be/en/faq/3921/systemic>)

# Summary

The information compiled in this report will be focussing on the recovery rate or efficiency and costs of current full scale proven nutrient recovery and reuse (NRR) techniques.

Data was acquired from scientific publications. Also existing biogas plants, including Demo Plants, Outreach Locations and Associate Plants and technology providers were approached for acquiring this information.

Criteria were set up to select cost-effective NRR technologies and based on these criteria the following technologies were identified:

- Liquid-solid separation techniques
- Nitrogen (ammonia) stripping-scrubbing
- Evaporation and condensation
- Phosphorus stripping and precipitation
- Drying

Additionally, for each technique common separation efficiency and nutrient recovery rates and costs are given. However, it is important to note that these can vary when the technology is used in a technology cascade (i.e. pre-or post-treatment, combination with other technologies).

Based on the outcomes of this report, a final selection of 21 technology cascades was chosen to be implemented in the NUTRICAS Tool.



# 1 Methodology

## 1.1 Targeted information

To select cost-effective NRR technologies for digestate, the following parameters will influence the cost-effectiveness of producing the NRR end products and their characteristics, which in turn influence their marketability.

- Investment costs and operational costs in relation to:
  - treatment capacity
  - nutrient, dry matter and water recovery efficiency
  - additives
  - energy requirements
  - storage requirements
- Separation efficiencies and recovery rates costs in relation to:
  - different types of digestate (e.i. feedstock mixtures). Relevant parameters for digestate are listed in Table 1-1
  - treatment capacity
  - Combination with other techniques (e.g. pre-treatment)
  - Operational conditions (temperature, pH)
  - Additives

*The recovery rate is defined as the fraction of the initial amount of mass, dry matter, organic matter, nutrients or minerals (N, P, K) that is recovered in the end product. It describes how efficient a technology can separate, concentrate or recover certain elements from the input.*

When a separation technology is used, the term "separation efficiency" (a.k.a. Separation Index, SI) is used for recovery rate.

The following formula is used to calculate the recovery rate.

$$\text{Recovery rate (Et)} = \frac{\text{mass}_{\text{end product}} (\text{kg}) \times \text{concentration}_{\text{end product}} \left(\frac{\text{g}}{\text{kg}}\right)}{\text{mass}_{\text{input}} (\text{kg}) \times \text{concentration}_{\text{input}} \left(\frac{\text{g}}{\text{kg}}\right)}$$

This fraction is usually expressed as a percentage. E.g. 10% of the mass of the initial digestate that is processed in a decanter centrifuge is found in the solid fraction.

Ultimately, the specific combination of all these parameters will result in a different cost-effectiveness for each biogas plant. Therefore, information on all these parameters will be targeted (Table 1-1).

Table 1-1 Parameters focussed on in data collection

Parameter			
Density	Mineral nitrogen (ammonium-N + nitrate-N + nitrite-N)	Total Phosphorus	Na
Viscosity	Ammonium Nitrogen (NH <sub>4</sub> -N)	Total P <sub>2</sub> O <sub>5</sub>	S
pH	Nitrite N (NO <sub>2</sub> <sup>-</sup> - N)	Organic phosphorus	Sulphates
Dry matter	Nitrate N (NO <sub>3</sub> <sup>-</sup> - N)	C:P ratio	Electrical conductivity
Organic dry matter	Organic nitrogen	Total potassium (K <sub>2</sub> O)	Cl
Total organic carbon	Kjeldahl-Nitrogen (organic N+ ammonium-N + nitrate-N)	Mg	F
Total Nitrogen (Ntotal)	C:N ratio	Ca	

## 1.2 Selection criteria and sources

As a starting point for selecting technologies, 2 criteria were set up:

### 1. Is the technology contributing to nutrient recovery?

I.e. during the processing, no nutrients are (deliberately) emitted to the air (e.g. nitrification-denitrification). The nutrients are separated and concentrated in one of the end products in a way that their concentration is higher than the initial digestate or more in line with certain crop demands.

### 2. Innovation adaption: Is the NRR technology running on full scale (TRL 7-8) by at least one biogas plant in Europe.

Under the assumption that they are cost-effective if they are implemented at full scale (Criterion 2), technologies complying to both these criteria were first found at the 5 Demo Plants. Next, other technologies implemented at the Outreach Locations (OL) and Associated Plants (AP) were benchmarked against the criteria and included when complying. Thirdly, scientific publications were searched for other complying technologies.

In the next step, to be able to evaluate the cost-effectiveness of each technology, supporting data (1.1 Targeted information) was gathered. In the case of the Demo Plant technologies, this data came from the monitoring campaigns done in SYSTEMIC and the construction of their

mass-and energy balances (WP1). Economic data came from the business case evaluation (WP2). Data from the OL and AP and other biogas plants was gained from direct communication or a widespread questionnaire, which will stay open until the end of the project (WP3).

Scientific publications, other project reports, consortium knowledge and technology providers were consulted to build up the supporting data.

All data was centralized in the "SYSTEMIC database". The SYSTEMIC database was a living file in which continuously data was added and will be during the project. It will be a part of the Business Development Package, available on <https://systemicproject.eu/business-development-package/>.

### 1.3 Structure of the database

To store and categorize the data on each technology, a database ("the SYSTEMIC database") was designed in Microsoft Excel® and put on the OneDrive for SYSTEMIC Consortium members.

Each record in the database gives information on a specific feedstock (mix), digestate or end product and contains values (e.g. analyses values, average values, median, 10 percentiles, etc.) for the recovery rate and/or the parameters described in Table 1-1.

If the record is an end product of a NRR technology (cascade), it also contains the technology (cascade) that is required to generate this specific end product.

An example is shown in Figure 1-1.

End product	after	Type	source	Referenc	unit NH4-N	P	unit P	mass (%)	DM (%)
digestate		digestate	pig slurry OBW	Møller, H. B., Somme	g N/L - kg N/m <sup>3</sup>		0,89 g P/L - kg P/m <sup>3</sup>		
liquid fraction	separation-centrifuge	digestate	pig slurry OBW	Møller, H. B., Somme			0,21 g P/L - kg P/m <sup>3</sup>		
solid fraction	separation-centrifuge	digestate	pig slurry OBW	Møller, H. B., Somme			5,9 g P/L - kg P/m <sup>3</sup>	13,72	69

Figure 1-1 3 records in the SYSTEMIC database.

The figure shows 3 records (digestate, liquid fraction and solid fraction after separation with a centrifuge). For each product the feedstock of the digestate is stated ("source") and the composition. In this figure only P content is visible. The recovery efficiency for mass and dry matter to the solid fraction of this separation technology on this digestate is also included ("mass (%)" and "DM (%)").

The records in the database are not all taken or analysed according to the same method and can be presented as single value, average, median,

minimum, maximum of multiple samples taken in different periods. This report will present the recovery rates as averages, however one cannot interpret these values as being absolute. They merely indicate a range in which the recovery rate of a certain technology might be found under certain conditions.

## 1.4 Collected data points

This report will show data based on the status of the database after 43 months from the beginning of the project (June 2017-December 2020). Table 1-2 gives the number of records added in this period.

The database will be updated further during the remaining time of the project. These, extra data can be used for optimizing the NUTRICAS Tool.

*Table 1-2 Number of records in the database on composition of digestate and end products or recovery rates (June 2017- December 2020)*

<b>Type of records</b>	<b>Number of records</b>
Scientific literature	686
Other data (analyses, reports with analyses, other databases etc.)	744
Demo Plants	169
Outreach Locations and Associated Plants	111
Other biogas plants	48
<b>Total records full scale plant data</b>	<b>1758</b>

## 1.5 Determining cost-efficiency of a technology

When a biogas plant operator considers investing in digestate processing, he needs to weigh investment options in their full business context. Meaning, completely assess the cost of the investment, by comparing operational scenarios with processing against those without, including the impact of all costs and revenues on the overall profitability of a venture over a given forecast period (Herbes et al. 2020). However, mapping the full business context is case specific and would include site-specific circumstances like the regional market environment for feedstock, availability of energy and heat from a CHP, energy prices,

technology supplier availability and cost for storage, transport and application.

These framework conditions don't fall under the scope of this report, which aims to give an overview of cost-effective technologies for digestate treatment as such. The advice is given to biogas plant owners to estimate future cash flows against investment outlays. And that the unit costs provided in this report can at best be only part of a profitability analysis (Adapted from (Herbes et al. 2020)).

In general, there are very many reports and tools summarising digestate treatment systems. They tend not to include costs, because these are often confidential, depend hugely on local situation and installation. Some contain cost estimates, more or less realistic, depending on whether they are based on models, technology supplier claims or real farm data. This information was included in the SYSTEMIC database. However, these estimations are rapidly outdated and therefore it could be debated to what extent they are useful when not adapted to a specific local or installation context.

To the extent that reliable data is present, this report will therefore attempt to make per technology a range for each recovery rate (Table 1-1), the investment costs and operational costs depending on the type of digestate, configuration, treating capacity, additives, etc. (Figure 1-2) Important influences of other parameters will be nuanced for each technology

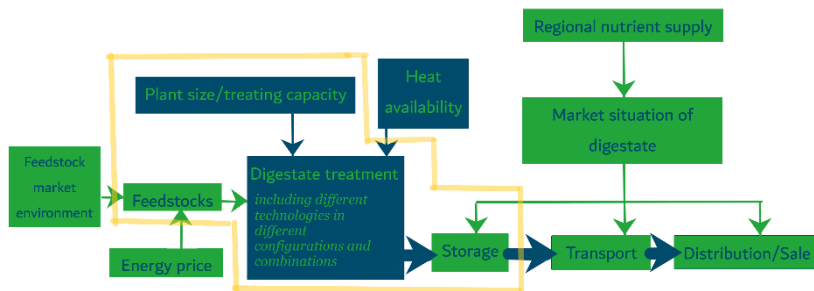

Figure 1-2 External conditions (green), internal conditions (blue). Conditions that will be attempted to be included in this report (yellow) Adapted from (Herbes et al. 2020)

**The capital expenditures (CAPEX)** are the investment costs for a NRR technology (cascade). Depreciation time and method, and interest rate will not be included in this report. Because, for the demo plants depreciation time and method was calculated for their complete process including the whole NRR cascade, and not per technology step. Details on this can be found in Deliverable 2.2 and 2.4 (Hermann and Hermann 2020b, 2020a).

**The operational expenditures (OPEX)** in this report aims to include only the pure processing cost, without cost of storage, transport and distribution of digestate- based products.

This means all costs for keeping the NRR technology (cascade) running: equipment maintenance costs, costs of chemicals and additives and labour costs.

For most of the technologies, the level of automatization has an impact on CAPEX or OPEX. In general, there are two options. The first is a higher level of automation where you won't need an operator present for much of the time. With this type of automation, you can eliminate much of the human error associated with running the plant, and although this option has a higher CAPEX (an initial investment in more sophisticated PLC controls and instrumentation), the ongoing labour costs (OPEX) are less. The second option is a lower level of automation with less capital cost, but with added labor, this can end up costing you more in the long run. When deciding whether or not to invest in more costly controls, you need to consider what works for your company and staffing availabilities.

## 2 Results

### 2.1 Feedstock types and digestate composition

Because the composition of the digestate depends largely on the feedstock mixture of the digester, different 'types' of digestates are possible. The composition of the digestate and end products is needed to be able to calculate the recovery rate of a certain technology and therefore. This information was also included in the database (Figure 1-1) and will also be valuable for the setting up the calculation models of the NUTRICAS Tool.

Additionally, other characteristics of the digestate (fibres, viscosity) can also have a large influence on the recovery rate and operational costs of a technology. Such relations will be discussed in the chapters on technologies, when enough reliable data or scientific evidence is available.

### 2.2 Selected technologies

Based on the criteria, the following **NRR technologies** were selected for this report:

- **Liquid-solid separation techniques**
  - *Decanter centrifuge*
  - *Screw press*
  - *Belt press*
- **Nitrogen (ammonia) stripping-scrubbing**
  - *pH elevation with CO<sub>2</sub> stripping or with caustic*
  - *scrubbing with acid or gypsum*
- **Evaporation and condensation**
  - *Vacuum, atmospheric pressure*
  - *Single phase, multiphase*
  - *Falling film, forced circulation*
  - *Addition of acid or not*
- **Phosphorus stripping and precipitation**
  - *RePeat, BioEcoSIM, NutriSep, Struvite precipitation*

- **Drying**
  - *Belt dryer*
  - *Fluidized bed dryer*
  - *Rotating disk dryer*
  - *Bio-thermal drying (composting)*

For each technology *several configurations or subtypes* are possible. The configurations described in this report, were chosen because they were applied at one of the demo plants, Outreach Locations or they appeared frequently in the database.

In the next chapters, each technology is described and a range is made of common separation efficiencies or recovery rates and costs. However, each technology (and configuration) can be used in different combinations with other technologies (i.e. cascades). This will also influence the efficiency and costs. Based on information from this report, several cascades will be selected to be included in the NUTRICAS Tool.

### 2.2.1 Liquid-solids separation

In general, separation of digestate produces a solid fraction with a higher organic matter and P content and a liquid fraction with a higher mineral N and K content.

Separation without any further treatment is usually done in nutrient surplus areas to reduce the volume of the digestate and/or to concentrate phosphorus in this smaller volume, the solid fraction.

The liquid fraction can be locally used as fertiliser, avoiding transport costs. The solid fraction has a much smaller volume compared to the initial digestate, and can be transported more economically on long distances where there is a need for nutrient rich products (Smit, Prins, and Hoop 2000). Another advantage is that the solid fraction can be stored under much simpler conditions. As an alternative to direct land application further stabilisation and transformation into a marketable product can be achieved through drying or composting (Chapter 2.2.6 and 2.2.7).

When recovering nutrients, organic matter or water from digestate, separation is frequently the first step in the treatment cascade. This is because it provides a first bulk separation of liquid and solids, making them easier to process further.



The separation efficiency is determined by the extent to which phosphate or the dry matter is retained in the solid fraction and varies by type of separator. Examples from the SYSTEMIC database are: decanter centrifuge, Screw press, belt press, Dissolved air flotation, metal edge separator, vacuum filter press, chamber filter press, rotary sieve, sieve drum, vibration screens, etc.

*Examples implemented at biogas plants*

- a decanter centrifuge to separate the digestate in liquid fraction and a solid fraction as a first step in a NRR cascade.( AM-Power, Waterleau New Energy, Groot Zevert Vergisting, several Outreach Locations)
- a screw press to separate organic soil improver from P-rich liquid fraction (RePeat system from WUR at Groot Zevert Vergisting, The Netherlands, Figure 2-25)
- a filter press to separate ammonium sulphate solution from calcium carbonate (FiberPlus® system from GNS at Benas Biogas Plant, Germany, Figure I-7)

Based on the criteria and amount of records available in the SYSTEMIC database, the centrifuge, screw press, belt press and DAF were selected to be described in this report.

The feedstock and operational conditions (pH, retention time and temperature) in the digester influence the digestate composition, its texture and viscosity. These characteristics of the digestate will influence the separation efficiency for dry matter and nutrients and therefore the final concentration of the solid and liquid fraction. This relation of different types of digestate (i.e. digestate characteristics) with the separation efficiency was not investigated further, due to lack of data on the feedstock composition in combination with separation efficiency.

## Use of additives

Addition of coagulation and/or flocculation agents can increase particle sizes of the suspended solids which form settleable and floating flocs that can be removed more efficiently during the mechanical separation process.

Raw digestate contains high amounts of colloid and fine particles, which have a negative charge and are stable in water: they repel each other and they don't sink or float of their own accord (Sievers, Jenner, and Hanna 1994). The addition of a coagulant (multivalent cations) will reduce the repulsion between the colloidal particles, by neutralizing the charge that prevents aggregation. This makes it possible to gather all the suspended material together. The resulting flocs are small and can only grow when calmly stirred, which will allow particles to further cluster together. A large number of coagulants are commercially available. A few examples of coagulants include multivalent cations like iron chloride ( $\text{Fe(III)Cl}_3$ ), polyaluminium chloride, iron chloride sulphate, polyamides and polytannins or low-molecular polymers (VITO 2010).

Additions of multivalent cations will enhance the precipitation of P due to formation of, for example,  $\text{FePO}_4$ ,  $\text{Fe}_5(\text{PO}_4)_2(\text{OH})_9$  and  $\text{Ca}_3(\text{PO}_4)_2$ . An optimum dose exists, and overdosing occurs when the adsorbed ions reverse the surface charge, thus counteracting aggregation (Gregory 1989). However, using these coagulants adds the iron or aluminium ions to the separated solid phase, and the liquid fraction becomes loaded with high concentrations of sulphates or chlorides, depending on the type of used coagulant. This could make the further use of separated digestate phases difficult or impossible (Heviánková et al. 2015). The addition of flocculants or flaking products can be added to aid and speed up this flocculation process (VITO 2010).

Flocculants are mostly polyelectrolyte polymers with a base that is formed by acrylic amide and its derivatives containing anion or cation groups of varying molecular weights, charge densities and molecule shapes (VITO 2010). It is important that the charge density is selected according to the nature of the digestate. Selecting the appropriate charge (and molecular weight) is necessary to obtain a higher separation efficiency. Polymers can be found as emulsions or as powders that need to be diluted in water to form a polymer solution. Emulsion polymers are liquid polymers containing mineral oil. Powder polymers are frequently ester-type polyacrylamides and are not bio-accumulative. However, high cationic powder polymer is not readily biodegradable, it does degrade abiotically by means of hydrolysis ( $T_{1/2} = 3.2$  days)(VLM 2018).

Also, the legislation differs in member states on which types of polymers are allowed for the safe use of the end products as fertilisers or soil improvers. For example, some member states allow polymers that are not petrogenic (For example, Flanders-Belgium). Powder polymers are often not petrogenic. Other examples are Finland, where all kind of polymers are allowed even in "organic certified" nutrient products. In Sweden polyacrylamide polymers are prohibited in "Krav" Organic certified nutrient products.

In general, for the safe use of solid fraction as fertiliser in agriculture, flocculants are preferred that are biodegradable. However, polyacrylamides are commonly used flocculants, they are very difficult to biodegrade. Additionally, the relatively high price (3 - 3.5€/kg) makes it desirable for the flocculating agent to be dosed as low as possible.

The price of powder polymers is mainly determined by the charge density, this is the percentage of the monomers with a charged group (5-80%). The charge density might be proportional to the price of the polymer.

In addition, branched polymers also exist and are usually slightly more expensive - even a very high molecular weight (chain length) can sometimes increase the price (personal communication, 2021).

A rare and expensive exception (<3.5€/kg up to 4.5€/kg) within the powder polymers are those made by spray drying a branched emulsion polymer. These are very hygroscopic products and usually have to be added in high amounts (personal communication, 2021).

Also, one has to keep in mind the potentially negative impact on sales due to reduced availability of  $P_2O_5$  in the solid fraction.

In practice, cationic polymer flocculating agents are often used to improve the separation of digestate, usually without inorganic auxiliary agents or coagulants, such as salts of iron or aluminium or lime (Heviánková et al. 2015, experience of SYSTEMIC biogas plants, 2020).

A higher level of optimisation (e.g. a higher P or dry matter separation efficiency) is not automatically obtained by adding a higher concentration of polymer. Also, the shear applied (for example, stirring velocity and time) are important factors here (Hjorth et al. 2010).

Therefore, often consultants are relied upon to help choosing the type of polymer (water- or oil based, powder polymer) and determine the concentration that should be added to the digestate (VCM 2018b). This is done on small scale via laboratory assessment (so called jar-tests) and confirmed and fine-tuned in full scale testing and operation.

## 2.2.1.1 Centrifuge

### 2.2.1.1.1 Technology description

A decanter centrifuge consists of a closed cylinder that rotates. Due to centrifugal forces, the heavy, undissolved particles like colloids, organic components and salts are propelled to the outside of the spinning centrifugal bowl, where they are collected on the screw conveyor. The liquid phase is transported to the other end of the centrifuge by rotating the entire centrifuge at high speed and by simultaneously rotating the conveyor at a speed that differs slightly from the speed of the bowl.



Figure 2-1 Horizontal decanter centrifuge  
Source: (Gorissen and Snauwaert 2018)

The solid particles and the liquid fraction are collected at separate outlets.

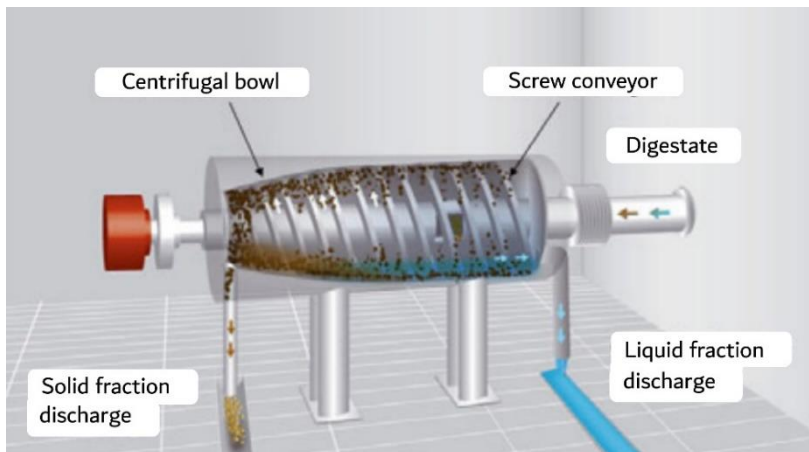

Figure 2-2 Scheme of a decanter centrifuge, source: adapted from (Hjorth et al. 2010)

Centrifuges are available in different capacities. The smallest centrifuges can treat around 1 m<sup>3</sup>/h but an average centrifuge for digestate treatment is between 8-30 m<sup>3</sup>/h. To obtain larger capacities, larger centrifuges are available (up to 90m<sup>3</sup>/h) or multiple centrifuges can be put in parallel (Lemmens et al. 2020).

#### **2.2.1.1.2 Separation efficiency**

Table 2-1 and Table 2-2 give some examples of digestates from the demo plants with the respective separation efficiency for mass, dry matter and nutrients to the solid fraction. The separation efficiency to the solid fraction (SF) % is complementary to the separation efficiency to the liquid fraction (LF) ( $SE_{SF}=100\%-SE_{LF}$ ).

Table 2-4 gives compares the data of the SYSTEMIC plants with the averages found in the SYSTEMIC database.

Centrifuges have a more selective separation of (particulate) organic compounds compared to inorganic soluble compounds like dissolved salts, hereby the  $SE_{OM} > SE_{DM}$  (T Gienau et al. 2018b). Also, approximately 50% of TP is related to smaller particles, between 0.45 and 10  $\mu\text{m}$  (Masse et al. 2005), which could aggregate during centrifugation. Other suspended P compounds include inorganic P-salts make up the other 20-30% of suspended phosphorus (Møller, Sommer, and Ahring 2002). Because of this, the largest part of the organic material and phosphate accumulate in the solid fraction and nitrogen and potassium mostly in the liquid fraction.

**Table 2-1 Analyses on digestate and related centrifuge separation efficiency to the solid fraction of different parameters from monitoring campaigns during the SYSTEMIC project at Groot Zevert Vergisting.**

*DMsus = suspended dry matter, DMsol = soluble dry matter, OM = organic matter, Total N = total nitrogen, NH4-N = ammonium nitrogen, Org-N = organic nitrogen, Total P = total phosphorus, Inorg-P = inorganic phosphorus, Org-P = organic phosphorus, Total K = total potassium, DC = decanter centrifuge, SE = separation efficiency, SF = solid fraction, LF = liquid fraction, PM = powder polymer*

		<sup>1</sup> Digestate	SE to SF %	<sup>2</sup> Digestate	SE to SF %	<sup>3</sup> Digestate	SE DC1 to SF %	<sup>4</sup> Digestate	SE DC 1 to SF%	<sup>4</sup> LF	SE DC2 to SF %
		No additives				MgCl <sub>2</sub> (32%)		MgCl <sub>2</sub> (32%)		Polymer solution	
Mass	Ton day <sup>-1</sup>		10	1000	14	326	16	210	13	183	14
Water	g kg <sup>-1</sup>	941.4	7								
DMsus	g kg <sup>-1</sup>	36.7	70	85	53	76.0	56	85.0	55		54
DMsol	g kg <sup>-1</sup>	21.9	7								
OM	g kg <sup>-1</sup>	19.3	70	60.3		52.0	59	61.0	52		48
Total N	g kg <sup>-1</sup>	6.6	15	7.7		6.9	30	6.9	77		72
NH <sub>4</sub> -N	g kg <sup>-1</sup>	5.5	7	4.3		4.6	25	3.9	82		87
Org-N	g kg <sup>-1</sup>	1.1	50								
Total P	g kg <sup>-1</sup>	1.0	70	1.86		1.7	73	1.7	35		34
Inorg-P	g kg <sup>-1</sup>	0.9	70								
Org-P	g kg <sup>-1</sup>	0.09	70								
Total K	g kg <sup>-1</sup>	4.8	7	4.5		4.2	19	4.2	87		87

<sup>1</sup> GZV 115kt feedstock per year: 64% pig slurry, 4% cattle slurry, 10.5% slaughterhouse manure, 18% Co-product dairy industry, 2.6% glycerine (Brienza et al. 2018) calculated and estimated figures by Nijhuis Industries, no chemicals added

<sup>2</sup> GZV 112kt feedstock per year: 67% pig slurry, 4.5% cattle slurry, 9% slaughterhouse manure, 16% Co-product dairy industry, 3.5% glycerine (Regelink et al. 2019) UCD 205 trailer decanter centrifuge (GEA Engineering), capacity 1-3 m<sup>3</sup>/h; DM capacity of 50-100 kg/h). Three tests were performed with feed rates of 2, 1 and 0.5 m<sup>3</sup>/h.

<sup>3</sup> GZV 112kt feedstock per year: 67% pig slurry, 4.5% cattle slurry, 9% slaughterhouse manure, 16% Co-product dairy industry, 3.5% glycerine (Brienza et al. 2019) April 24th and May 7th 2019 average of samples taken (n=2) With MgCl<sub>2</sub> addition 1.75L/m<sup>3</sup> digestate

<sup>4</sup> GZV 112kt per year: 67% pig slurry, 4.5% cattle slurry, 9% slaughterhouse manure, 16% Co-product dairy industry, 3.5% glycerine (Brienza et al. 2020) (T07 – T10): 22-10-2019 – 29-1-2020; average of samples taken.

2 decanter centrifuges in series: With MgCl<sub>2</sub> addition 7-9L/m<sup>3</sup> digestate in D1 and (60-80L PM solution/m<sup>3</sup> liquid fraction) 0.2-0.27kg PM/m<sup>3</sup> liquid fraction in DC2

*Table 2-2 Analyses on input of the centrifuge and related centrifuge separation efficiency to the solid fraction of different parameters from monitoring campaigns during the SYSTEMIC project at AM-Power.*

*DM = dry matter, OM = organic matter, Total N = total nitrogen, NH<sub>4</sub>-N = ammonium nitrogen, Total P = total phosphorus, Total K = total potassium, LF = liquid fraction, SF = solid fraction, SE = separation efficiency*

		<sup>1</sup> <b>Digestate + LF (6:4)</b>	<b>SE to SF %</b>	<sup>2</sup> <b>mixture storage 81</b>	<b>SE to SF %</b>	<sup>3</sup> <b>Digestate</b>	<b>SE to SF %</b>	<sup>4</sup> <b>Digestate</b>	<b>SE to SF %</b>
		Polymer solution and FeSO <sub>4</sub>		Polymer solution and FeSO <sub>4</sub>		Polymer solution		Polymer solution	
Mass	Ton day <sup>-1</sup>				8.8	102	9.5	270	22
DM	g kg <sup>-1</sup>	70		43		68 ± 12	38	82±2.4	73
OM	g kg <sup>-1</sup>	35		19				49±2.9	78
Total N	g kg <sup>-1</sup>	4.8		4.1	29	5.5 ± 0.08	17	5.0±0.2	50
NH <sub>4</sub> -N	g kg <sup>-1</sup>	2.6		0.28					
Total P	g kg <sup>-1</sup>	2.3		0.7	87	1.3	40	1.2±0.1	94
Total K	g kg <sup>-1</sup>	2.5		2.7	10.3	3.5	9.1	3.5±0.3	32

<sup>1</sup> AM-Power 167kt feedstock/year: 13% pig manure, 72% food and food industry waste, 3% glycerine and fats, 0.1% corn, 13% other organic waste. (Brienza et al. 2018) March 2017 (n=1). Addition of polymer (3.5% solution 100L/m<sup>3</sup> ) and FeSO<sub>4</sub> (40% 225L/24m<sup>3</sup>)

<sup>2</sup> AM-Power:137.6kt feedstock /year: 9% pig manure, 81% food and food industry waste, 8% glycerine and fats, 0.1% corn, 2% other organic waste. (Brienza et al. 2019) average of samples taken in September–October 2018 (n=2). Mixture storage 81 (0.35% solution 100L/m<sup>3</sup> ) and FeSO<sub>4</sub> (40% 225L/24m<sup>3</sup>)

<sup>3</sup> AM-Power:161.3kt feedstock /year: 10% pig manure, 80% food and food industry waste, 6% glycerine and fats, 0.1% corn, 4% other organic waste. (Brienza et al. 2020) average of samples taken in the period February 2020 (n=2; when standard deviation is included n=4). Polymer addition: 32L (0.5%polymer solution) /ton digestate

<sup>4</sup> AM-Power:161.3kt feedstock /year: 10% pig manure, 80% food and food industry waste, 6% glycerine and fats, 0.1% corn, 4% other organic waste average of samples taken in the period (October 2020- January 2021) (n=3) Polymer addition: 26-50L (0.5%polymer solution) /ton digestate

*Table 2-3 Analyses on input of the centrifuge and estimations of the centrifuge separation efficiency to the solid fraction of different parameters from SYSTEMIC Outreach Locations.*

*DM = dry matter, OM = organic matter, Total N = total nitrogen, NH<sub>4</sub>-N = ammonium nitrogen, Total P = total phosphorus, Total K = total potassium, LF = liquid fraction, SF = solid fraction, DC= decanter centrifuge*

		<sup>1</sup> Sanitized digestate	Separation efficiency SF %	<sup>2</sup> Digestate	Separation efficiency SF %	<sup>3</sup> digestate	Separation efficiency SF %
		With polymer		With polymer		With polymer	
Mass	Ton day <sup>-1</sup>	11	12		30		21
DM	g kg <sup>-1</sup>	52±2.2	59	117	63	80	86
OM	g kg <sup>-1</sup>	33±5.6	65				
Total N	g kg <sup>-1</sup>	3.2±1.7	34	7.32	10-20	6	45
NH <sub>4</sub> -N	g kg <sup>-1</sup>						
Total P	g kg <sup>-1</sup>	0.99±0.25	79	2.4	40	1.7	87
Total K	g kg <sup>-1</sup>	3.7±0.74	13	5.7	5-10	1.7	14

<sup>1</sup> Waterleau New Energy: 38% manure and solid fraction of manure, 18% sewage sludge, 42% agricultural waste

2 centrifuges in parallel. DC1: 4 m<sup>3</sup> digestate/h and DC2: 7 m<sup>3</sup> digestate/h.

Average: 11 m<sup>3</sup> digestate /h.

average of samples taken in the period June-December 2020 (n=5)

Powder polymer + 1200 -1300L water/h (0.3% solution)

<sup>2</sup> Biogas Bree 66 kt/year: 43% agricultural residues, 56% bio-waste, food industry/supermarket waste. 1 sample from 2018. Estimations of recovery rate based on operator knowledge. No closed mass balance was used. Polymer consumption not known.

<sup>3</sup> Emeraude bioenergy: 156kt feedstock/year: 24% pig slurry, 41% slaughterhouse waste, 34% recycled water. Estimations of recovery rate based on operator knowledge. No closed mass balance was used. 8g polymer added per kg DM of the input of the centrifuge.



Table 2-4 Summary of separation efficiencies of centrifuges to the solid fraction of different parameters from Table 2-1, Table 2-2, Table 2-3 and the SYSTEMIC database.

DM = dry matter, OM = organic matter, Total N = total nitrogen, NH<sub>4</sub>-N = ammonium nitrogen, Total P = total phosphorus, Total K = total potassium, SF = solid fraction, GZV = Groot Zevent Vergisting, DC= decanter centrifuge

Separation efficiency to SF %		Mass	DM	OM	Total N	NH <sub>4</sub> -N	Total P	Total K
<sup>1</sup> GZV	without polymer	11	46	70	15	7	70	7
<sup>2</sup> Database	without polymer	14±8	59±17	81±11	31±21	17±12	76±18	28±12
<sup>3</sup> SYSTEMIC plants		9.5-30	38-86		10-45		40-87	5-14
<sup>2</sup> Database	with polymer	21±12	76±19	85±7	34±12	24±5	82±14	40±12
<sup>4</sup> GZV DC2 (after DC1)		14	54	48	72	87	34	87
<sup>5</sup> Database Centrifuge (after screw press)	With polymer Without polymer	9±9	74±10		40±12	15±4	93±3	16±7
<sup>6</sup> Database	No data	10±2	51±13	40±7	27±13	12±4	58±22	14±7

<sup>1</sup> Summary of the data in Table 2-1

<sup>2</sup> SYSTEMIC database (December 2020): filtered on Type of input: "digestate", end product: "solid fraction", after: "separation-centrifuge", chemical: "no polymer". Average SE ±Stdev.P; mass(n=15) , DM (n=13), OM (n=6), Total N (n=13), NH<sub>4</sub>-N(n=6), Total P(n=14), Total K (n=6)

<sup>3</sup> Summary of the data in Table 2-2, Table 2-3; minimum-maximum

SYSTEMIC database (December 2020): filtered on Type of input: "digestate", end product: "solid fraction", after: "separation-centrifuge", chemical: "polymer". Average SE ±Stdev.P; mass(n=15) , DM (n=12), OM (n=9), Total N (n=7), NH<sub>4</sub>-N(n=4), Total P(n=7), Total K (n=2)

<sup>4</sup> Table 2-1, GZV: 2 decanter centrifuges in series, separator efficiency DC2

<sup>5</sup> SYSTEMIC database (December 2020): filtered on Type of input: "digestate", end product: "solid fraction", after: "separation-screw press + separation-centrifuge", Average SE ±Stdev.P; mass(n=7) , DM (n=2), Total N (n=2), NH<sub>4</sub>-N(n=2), Total P(n=2), Total K (n=2)

<sup>6</sup> SYSTEMIC database (December 2020): filtered on Type of input: "digestate", end product: "solid fraction", after: "separation-centrifuge", chemical: empty (i.e. no data available on additive use). Average SE ±Stdev.P; mass(n=8) , DM (n=9), OM (n=4), Total N (n=10), NH<sub>4</sub>-N(n=4), Total P(n=9), Total K (n=5)

**The use of additives**, such as coagulants (e.g.  $\text{FeCl}_3$ ,  $\text{Fe}_2(\text{SO}_4)_3$ , etc.) or flocculants, is frequently done in practice to improve separation efficiency of digestate in a centrifuge. Table 2-4 shows higher SE for dry matter and phosphorus when polymers are added. A relation with the amount of coagulants and flocculants was found in (Cocolo 2012). Here, a test was performed with digestate from the co-digestion of pig, cattle and poultry manure with biomasses (corn and triticale silages) from a collective treatment plant. The flocculating agent was a linear cationic polymer (0.7% concentration), with a charge density of 40% and a medium-high molecular weight (Hidrofloc CL1704, Hidrodepur, Italy). Applying different amounts of polymer gave the following results in the separation efficiency (Figure 2-3).

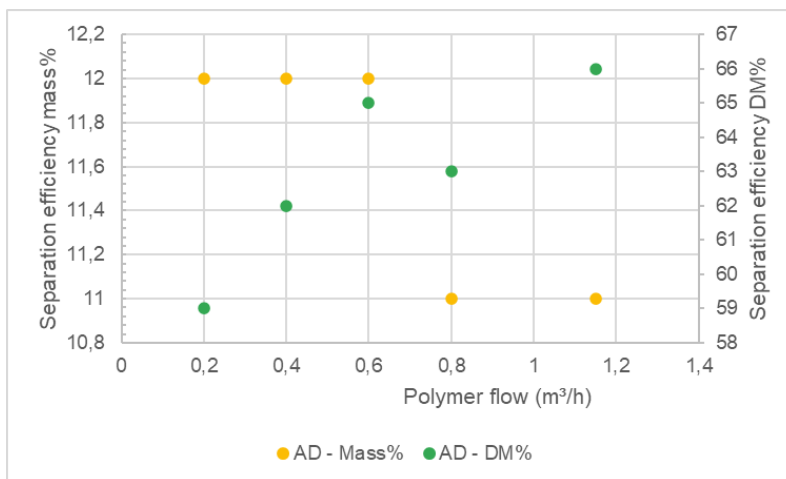

*Figure 2-3 Separation efficiencies for mass and dry matter for digestate in a centrifuge, with different amounts of polymer added. Adapted from (Cocolo 2012)*

The separation efficiency increased at increasing amounts of added polymer till a maximum value.

**Combination with other techniques** (e.g. pre-treatment) was only seen in 17 records in the database and included 2 centrifuges in series (Table 2-1: 4) and combination of a screw press and centrifuge (Table 2-4: 5). In Table 2-4, these separation efficiencies can be compared with single step centrifuge separation. However, this cannot be accounted for as reliable conclusions due to the low amount of data.

Only one publication was found on the effect of pre-treatment on polymer consumption and separation efficiency. A test performed by (Cocolo 2012)

showed the variation in separation efficiency of liquid fraction of digestate after a screw press, separated in a centrifuge, while the amount of polymer was varied (Figure 2-4). The same addition of polymer resulted in lower separation efficiencies compared to raw digestate. This is due to the higher amount of coarse particles contained in the raw digestate, which will be easier separated centrifugation. Therefore the polymer dosage required for the separation of liquid fraction is higher for reaching the same separation efficiency (Cocolo 2012).

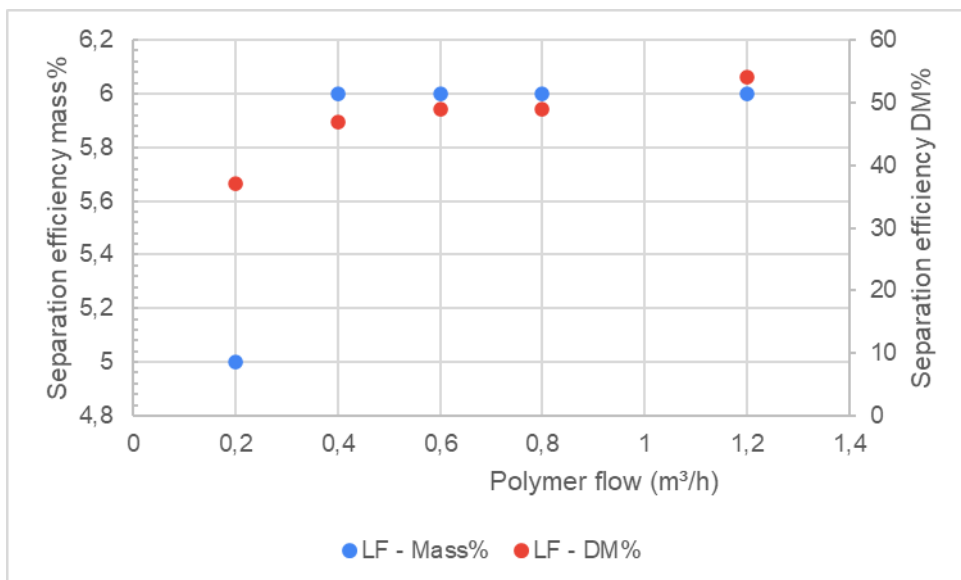

Figure 2-4 Separation efficiencies for mass and dry matter for liquid fraction of digestate, separated in a centrifuge, with different amounts of polymer added. Adapted from (Cocolo 2012)

### Composition of the end products

According to the SYSTEMIC database, a solid fraction of digestate after a centrifuge has an average DM percentage of  $27 \pm 14\%$  ( $n=80$ ). DM% of 25-30% is stackable and transportable, without creating dust (Bamelis 2016). More details on products can be found in the SYSTEMIC product fact sheets.

### Treatment capacity

The relation of the treating capacity of the centrifuge with the SE was not investigated further, due to lack of data. But it is assumed that centrifuges (large or small) have equal performance.

#### **2.2.1.1.3 Energy requirements**

The decanter centrifuge of Groot Zevent Vergisting is estimated to consume 1.2 kWh/m<sup>3</sup> of digestate that is treated (Brienza et al. 2018).

In (Brienza et al. 2019) an average electricity consumption of 0.23 kWh/m<sup>3</sup> of digestate is calculated for separation of the digestate in 2 centrifuges in series. This is calculated based on an incoming amount of digestate of 70000 m<sup>3</sup>/year and a reported electricity consumption of 300 MWh/year for the centrifuges.

The centrifuge of AM-Power had an electrical power capacity of 80-120 kWe (Brienza et al. 2019).

Other values are found in the database, describing centrifuges with treatment capacity of 6ton/h having a power capacity ranging from 0.11kWe to 14 kWe (n = 4). An average electrical energy consumption  $\pm$ Stdev.P, assumed for treating 6-40 ton/h is calculated as  $3.4 \pm 3.01$  kWh/m<sup>3</sup> digestate treated in a centrifuge (n=10). Due to the lack of data and details in the data, the accurateness of these values is uncertain.

No heat is required for operating a decanter centrifuge.

#### **2.2.1.1.4 Storage capacity**

A centrifuge treating up to 15 tons per hour has a footprint of about 3 m<sup>2</sup>. Storage capacity for the produced liquid and solid fraction can be calculated based on the treated volumes and separation efficiency.

#### **2.2.1.1.5 Costs**

**The capital expenditures (CAPEX)** are the investment costs. Table 2-5 gives some indicative values for CAPEX of a decanter centrifuge in relation to the treatment capacity.

Table 2-5 CAPEX vs treatment capacity of a centrifuge (SYSTEMIC database, December 2020)

<b>Treatment capacity (ton/h)</b>	<b>CAPEX (€) Average ±Stdev.P</b>	<b>n</b>
<b>2</b>	86,333±22,965	15
<b>5</b>	93,321±21,892	14
<b>7</b>	155,000±47,081	3
<b>8</b>	81,535	1
<b>12</b>	81,535	1
<b>15</b>	145,000±7,071	3
<b>20</b>	100,000	1
<b>30</b>	171,667±30,641	3
<b>50</b>	250,000±40,825	3
<b>90</b>	300,000	1

The large variances can be attributed to the fact that some CAPEX data contain also the costs for installation of the technology and programming of the Programmable Logic Controller (PLC). These extra costs are not always specified, so a 'clean' figure for the cost of only a centrifuge was not possible to obtain.

Data from the SYSTEMIC database were based on a.o. (Bamelis 2016; Lemmens et al. 2020; Postma et al. 2013; STIM and VCM 2004) and personal communication with consultants and technology suppliers like Slootsmid, GEA, Nijhuis, DLV-United Experts.

A polymer dosing unit is estimated to cost between 12.0000 and 50.000€ (Bamelis 2016) and one is needed per centrifuge.

**The operational expenditures (OPEX**, here considered as the pure processing cost, can include various costs like equipment maintenance costs, costs of chemicals and additives and labour costs.

If OPEX data was found, it generally an estimation on a yearly base, which was often reported as a percentage of the CAPEX (Table 2-6).

Table 2-6 Data on the OPEX of the centrifuge from the SYSTEMIC database, December 2020.

Source	OPEX	Remarks
(Postma et al. 2012)	5% of CAPEX	Cost breakdown not specified
Estimation Nijhuis, DLV-united experts	3%	Only maintenance?
Estimation VP Hobe	5-7%	Only maintenance?
(Agentschap NL, NL Energie en Klimaat, 2010)	1-5€/ton input	Excl. Storage, and with continuous use
(Block 2009)	0.63€/m <sup>3</sup> input	2000 kW plant Cost breakdown not specified
(Schröder et al. 2009)	5%	Only maintenance
(Brienza et al. 2018)	25,000 € + 1% of CAPEX	Only maintenance
(Barampouti et al. 2020)	3.68€/m <sup>3</sup>	CAPEX+OPEX

The large variation can be attributed to the fact that it was also not always clear which cost items were included in this percentage.

Due to their mode of operation (i.e. fast rotating cylinder), centrifuges are more susceptible to sand abrasion than the other types of separators. Separation of digestate types containing more sand, plastics or stones could result therefore in higher maintenance costs.

### **Cost of chemicals**

Based on data from suppliers and biogas plants a polymers cost between 2.5-3.5 €/kg, depending on the charge density and molecular weight.

The amount of flocculants (polymers) dosed in a centrifuge ranges from 2-14 kg powder PM/ton DM of the digestate (Excel tool separation GEA;Heviánková et al., 2015; Bamelis, 2016). Some demo plants use powder polymers dissolved in water at concentrations of 0.3% or 0.7%. This would be an amount of 0.05-0.35 kg powder polymer used per m<sup>3</sup> digestate. This renders a polymer cost of 0.15 – 1/m<sup>3</sup> of digestate (assumed 3€/ kg powder polymer).

However, the amounts can vary depending on the type of digestate and the finetuning of the separation with polymer addition.

## 2.2.1.2 Screw press

### 2.2.1.2.1 Technology description

A screw press (or screw press filter or press auger) is a machine in which a large screw rotates within a cylindrical screen with 0.1-1 mm holes. The liquid fraction is physically separated from the rest of the digestate through these perforations and is collected in a container surrounding the screen. Separation is therefore based on particle size. The screw provides a gradual increase in pressure and at the end of the axle the solid fraction will be pressed against the plate and more liquid is pressed out. The separation efficiency can be adapted by the counter pressure of the outlet opening.



Figure 2-5 Screw press. Source: (Gorissen and Snauwaert 2018)

The solid fraction is retained by this plate and goes out through an outlet pipe. The separation efficiency can be adapted by the counter pressure of the outlet opening. Typical capacities of screw presses are around 2-15 m<sup>3</sup>/h (Lemmens et al. 2020; Postma et al. 2012).

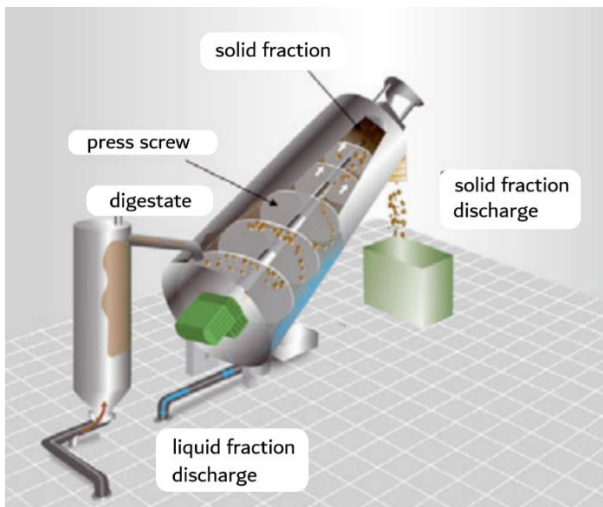

Figure 2-6 Scheme of a screw press, source: adapted from (Hjorth et al. 2010)

### 2.2.1.2.2 Separation efficiency

Table 2-7 gives an example of separation efficiency for mass, dry matter and nutrients to the solid fraction for Demo Plant Groot Zevent Vergisting. The screw press is used as a starting point for the RePeat cascade (Figure 2-25).

Table 2-8 shows the efficiencies of the screw presses working in the NRR cascade at the Benas Demo plant (Figure 2-7). Table 2-9 gives examples of separation efficiencies from SYSTEMIC Associated Plants.

Table 2-10 compares the data of the SYSTEMIC plants with the averages found in the SYSTEMIC database.

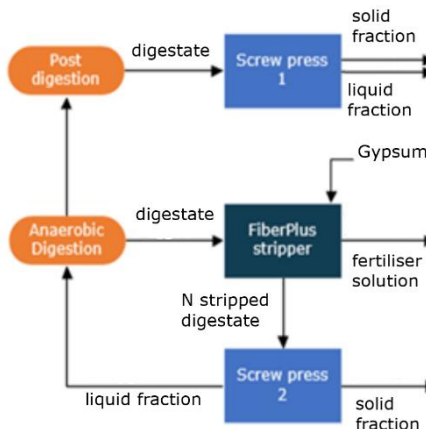

Figure 2-7 Process scheme of Benas including the 2 screw presses.

Table 2-7 Separation efficiencies of first screw press to the solid fraction in the RePeat process at Groot Zevent Vergisting (Brienza et al. 2020).

DM = dry matter, OM = organic matter, Total N = total nitrogen, NH<sub>4</sub>-N = ammonium nitrogen, Total P = total phosphorus, Total K = total potassium, SF= solid fraction

		<sup>1</sup> solid fraction after centrifuge (= input screw press 1)	Separation efficiency to SF %
Mass	Ton day <sup>-1</sup>		22
DM	g kg <sup>-1</sup>	329	65
OM	g kg <sup>-1</sup>	254	75
Total N	g kg <sup>-1</sup>	12.6	30
NH <sub>4</sub> -N	g kg <sup>-1</sup>	6.1	30
Total P	g kg <sup>-1</sup>	9.1	30
Total K	g kg <sup>-1</sup>	4.6	18

<sup>1</sup> GZV 112kt per year: 67% pig slurry, 4.5% cattle slurry, 9% slaughterhouse manure, 16% Co-product dairy industry, 3.5% glycerine

Solid fraction of digestate after centrifuges going to screw press 1: average of T01-T02(7/4/2020 - 11/5/2020) (n=2). No coagulants or flocculants added to the screw press.



Table 2-8 Separation efficiencies of the screw press to the solid fraction at Demo Plant Benas.

DM = dry matter, OM = organic matter, Total N = total nitrogen, NH<sub>4</sub>-N = ammonium nitrogen, Total P = total phosphorus, Total K = total potassium, SF= solid fraction

		<sup>1</sup> digestate	Separation efficiency to SF %	<sup>2</sup> N stripped digestate	Separation efficiency to SF %	<sup>3</sup> digestate	Separation efficiency to SF %
Mass	Ton day <sup>-1</sup>	224.6	21	208.1	5		20
DM	g kg <sup>-1</sup>	127	32	124.4	12	110 ± 16	41
OM	g kg <sup>-1</sup>	85		86	14	75 ± 14	48
Total N	g kg <sup>-1</sup>	7.7	19	6.2	4	7.9 ± 2.1	22
NH <sub>4</sub> -N	g kg <sup>-1</sup>	3.8	11	0.7	0.4	4.4 ± 0.43	20
Total P	g kg <sup>-1</sup>	2.25	28	2.3	7	1.6 ± 0.26	28
Total K	g kg <sup>-1</sup>	7.3	18	7.8	5	6.9 ± 0.73	16

<sup>1</sup> Benas 9.58 kt per year: 35% Chicken manure, 30% Rye silage, 28% Corn silage, 4.7% Grain flour, 2.6% Grass silage

(Brienza et al. 2019) Solid fraction of digestate after screw press 1: average (August 2017). No coagulants or flocculants added to the screw press.

<sup>2</sup> Benas 9.58 kt per year: 35% Chicken manure, 30% Rye silage, 28% Corn silage, 4.7% Grain flour, 2.6% Grass silage

(Brienza et al. 2019) Solid fraction of N-stripped digestate after screw press 2: average (August 2017) (n=). No coagulants or flocculants added to the screw press.

<sup>3</sup> Benas 28.2kt per year: 62% Corn silage, 3% Corn grain, 28% Chicken manure, 5% Grass silage, 0.8% Goose manure, 0.7% Millet

(Brienza et al. 2020) Solid fraction of digestate after screw press 1: average (January-April 2019) (n=12). No coagulants or flocculants added to the screw press.

*Table 2-9 Estimations of Screw press separation efficiency to the solid fraction of different parameters from SYSTEMIC Associated Plants*

*DM = dry matter, OM = organic matter, Total N = total nitrogen, NH<sub>4</sub>-N = ammonium nitrogen, Total P = total phosphorus, Total K = total potassium, , SF = solid fraction*

	<sup>1</sup> Digestate	Separation efficiency SF %	<sup>2</sup> Digestate	Separation efficiency SF %	<sup>3</sup> digestate	Separation efficiency SF %
Mass	20.000m <sup>3</sup> /year	15	63.000 m <sup>3</sup> /year	10	45.000 m <sup>3</sup> /year	10
DM g kg <sup>-1</sup>	80	56	9	40	23	77
OM g kg <sup>-1</sup>					19	82
Total N g kg <sup>-1</sup>	5		5	28	5	10
NH <sub>4</sub> -N g kg <sup>-1</sup>	0		2		1	10
Total P g kg <sup>-1</sup>	0	100	0.436		1.3	70
Total K g kg <sup>-1</sup>	0.83	15	0		3.3	33

<sup>1</sup> Biogas Plant in Belgium: feedstock 20kt/year:25% pig slurry, 25% cattle manure, 25% corn and 25% other organic biological waste  
No coagulants or flocculants added to the screw press.  
(biogas plant 4; information provided by plant operator on Survey SYSTEMIC 15/05/2019).  
Estimations of recovery rate based on operator knowledge.

<sup>2</sup> Biogas Plant in Italy: feedstock 70 kt/year:58% cattle slurry, 42% cattle manure (solid)  
No coagulants or flocculants added to the screw press.  
(biogas plant 5; information provided by plant operator on Survey SYSTEMIC 15/05/2019).  
Estimations of recovery rate based on operator knowledge.

<sup>3</sup> Biogas Plant in Belgium: feedstock 45 kt/year:13% corn, 87% other organic biological waste  
No coagulants or flocculants added to the screw press.  
(biogas plant 11; information provided by plant operator on Survey SYSTEMIC 20/05/2019).  
Estimations of recovery rate based on operator knowledge.

*Table 2-10 Summary of separation efficiencies of screw presses to the solid fraction of different parameters from the SYSTEMIC plants and the SYSTEMIC database.*

<b>SE to SF %</b>		Mass	DM	OM	Total N	NH <sub>4</sub> -N	Total P	Total K
<sup>1</sup>		10-22	32-77	48-82	10-30	10-30	28-100	15-33
SYSTEMIC Plants	with out PM							
<sup>2</sup>	Database	12±8	33±14	35±11	15±6	11±4	28±11	11±7
<sup>3</sup>	Database	37±18	73	20±28	24±9	19	60±25	15
	with PM							

<sup>1</sup> Summary of the data in Table 2-7 and Table 2-8 and Table 2-9, minimum-maximum values

<sup>2</sup> SYSTEMIC database (December 2020): filtered on Type of input: "digestate", end product: "solid fraction", after: "separation-screw press", chemical: "no polymer"  
Average SE ±Stdev.P; mass(n=15) , DM (n=16), OM (n=12), Total N (n=7)),NH<sub>4</sub>-N(n=2), Total P(n=6), Total K (n=6)

<sup>3</sup> SYSTEMIC database (December 2020): filtered on Type of input: "digestate", end product: "solid fraction", after: "separation-screw press", chemical: "polymer"  
Average SE ±Stdev.P; mass(n=3) , DM (n=1), OM (n=3), Total N (n=2),NH<sub>4</sub>-N(n=1), Total P(n=2), Total K (n=1)

A screw press is mainly suitable for obtaining a high dry matter content in the solid fraction as opposed to the separation of nutrients. This makes the solid fraction suitable for stall bedding. Because a screw press only separates coarse particles, small particles are contained in the liquid fraction. Also, anaerobic digestion will enhance this, because it degrades most of the organic compounds, which makes the average particle size of particles in digestate also lower than in the initial feedstock (Masse et al. 2005). In general, digestate contains very few fibres compared to (cattle) manure which makes it hard to separate with a screw press. Nonetheless, in practice, separation of digestate from mono-digestion of cattle manure or co-digestion with maize is also done with a screw press (communication with SYSTEMIC plants, 2018).

At a higher dry matter content of the ingoing digestate, a solid fraction with a higher dry matter is obtained. Also the separation efficiencies of N, P and K increase (VLM 2018).

The **use of additives** like flocculants, is sometimes done in practice to improve separation efficiency of digestate in a screw press. Table 2-10 shows higher SE for mass, dry matter and phosphorus when polymers are added.

**Combination with other techniques** (e.g. pre-treatment) was seen in the the RePeat cascade of Groot Zevert Vergisting (Figure 2-25) and Benas (Figure 2-7). The screw press is used in both cases to obtain a high separation of dry matter. In the case of Groot Zevert to recover the P stripped solid fraction and for Benas to recover the fibres from the N stripped digestate.

### **Composition of the end products**

According to the SYSTEMIC database, a solid fraction of digestate after a screw press has an average DM percentage of  $23\pm 8\%$  ( $n=87$ ). More details on products can be found in the SYSTEMIC product fact sheets.

### **Treatment capacity**

The relation of the treating capacity of the screw press with the SE was not investigated further, due to lack of data. But it is assumed that screw presses (large or small) have equal performance. If larger capacity is needed, multiple screw presses can also be put in parallel.

#### **2.2.1.2.3 Energy requirements**

The energy consumption of the screw press at the Demo plants Groot Zevert and Benas were not individually measured or calculated.

Other values are found in the database, describing screw presses with treatment capacity of 6 ton/h having a power capacity ranging from 4 kWe to 5.5 kWe ( $n = 3$ ). An average electrical energy consumption  $\pm$ Stdev.P, assumed for treating 6 ton/h is calculated as  $0.67\pm 0.39$  kWh/m<sup>3</sup> digestate treated in a screw press ( $n=13$ ). Due to the lack of data and details in the data, the accurateness of these values is uncertain.

No heat is required for operating a screw press.

#### **2.2.1.2.4 Storage capacity**

A screw press treating up to 10 tons/hour has a footprint of about 3m<sup>2</sup>. Storage capacity for the produced liquid and solid fraction can be calculated based on the treated volumes and separation efficiency.

#### **2.2.1.2.5 Costs**

**The capital expenditures (CAPEX)** are the investment costs. Table 2-11 gives some values for CAPEX of a screw press in relation to the treatment capacity.

Table 2-11 CAPEX vs treatment capacity of a screw press (SYSTEMIC database, December 2020)

Treatment capacity (ton/h)	CAPEX (€)	n
	Average ±Stdev.P	
2	25,625±14,402	4
3	36,187±10,717	8
4	30,416±14,119	3
5	39,571±14,529	7
6-6.5	28,750±13,404	4
8	34,583±9,176	6
9	44,400	1
10	24,062±4,542	4
12	52,500	1
15.5	17,000	1

The large variances can be attributed to the fact that some CAPEX data contain also the costs for installation of the technology and programming of the Programmable Logic Controller (PLC). These extra costs are not always specified, so a 'clean' figure for the cost of only a screw press was not possible to obtain. For achieving higher treatment capacity, it is possible to put multiple screw presses in parallel. This was also not always specified but does have an impact on the price.

Data from the SYSTEMIC database was based on a.o. (Bamelis 2016; Lemmens et al. 2020; Postma et al. 2013) and personal communication with consultants and technology suppliers like Nijhuis and DLV-United Experts.

(Herbes et al. 2020) estimated the CAPEX of a screw press on 0.42€/m<sup>3</sup> digestate treated. This is in line with the values in the SYSTEMIC database.

A polymer dosing unit is estimated to cost between 12.000 and 50.000€ (Bamelis 2016) and one is needed per screw press.

**The operational expenditures (OPEX, here considered as the pure processing cost,** can include various costs like equipment maintenance costs, costs of chemicals and additives and labour costs.

If OPEX data was found, it generally an estimation on a yearly base, which was often reported as a percentage of the CAPEX (Table 2-12).

*Table 2-12 Data on the OPEX of a screw press from the SYSTEMIC database, December 2020.*

<b>Source</b>	<b>OPEX</b>	<b>Remarks</b>
(Postma et al. 2013)	5%	Cost breakdown not specified
(Evers et al. 2010)	17.8%	Based on 5% interest, 10% depreciation, 5% maintenance en 10% residual value
Estimation Nijhuis, DLV- united experts	3%	Cost breakdown not specified
(Schröder et al. 2009)	5%	Only maintenance
(Bamelis 2016)	0.5-3€/ton digestate	Cost breakdown not specified
(Herbes et al. 2020)	0.05€/m <sup>3</sup> digestate	Operation and labour 500kW and 2000kWh H+; R-scenario
(Barampouti et al. 2020)	0.54€/m <sup>3</sup>	CAPEX+OPEX

The labour expenditure was estimated at approx. 15min per day (Bauer et al. 2009).

The large variation can be attributed to the fact that it was also not always clear which cost items were included in this percentage.

### **Cost of chemicals**

Based on data from suppliers and biogas plants polymers can cost between 2.5-3.5 €/kg.

Amounts of polymer added varied between 9-10 kg polymer/ton DM (Bamelis 2016, GEA separation tool) and 56 g polymer/m<sup>3</sup> digestate (solution of 62% 0.09L solution/m<sup>3</sup> digestate) ( Biogas Plant in Sweden, Survey SYSTEMIC 24-05-2019).

As seen in these examples, the amounts used can vary depending on the type of digestate and the finetuning of the separation with polymer addition.

### 2.2.1.3 Belt press

#### 2.2.1.3.1 Technology description

A belt press consists of two water-permeable belts guided over several rolls. The belts are pressed against each other over a certain length. This way shear forces and mechanical pressure are generated between two belts to de-water the digestate.

The process typically consists of three stages; gravity, low pressure and high pressure. The digestate is fed between the two belts where the water is first removed via gravity. In the second section, pressure is applied as the belts pass through a series of rollers and the water is pressed out under increasing pressure. The final de-watered solid fraction or "cake" is removed from the belts by scraper blades. Belt presses can treat on average 2-40 m<sup>3</sup>/h. (Postma et al. 2012).



Figure 2-8 Belt press. Source: VP-Hobe, installed at BioStorg Biogas Plant, Houthalen-Helchteren, Belgium, 2019.

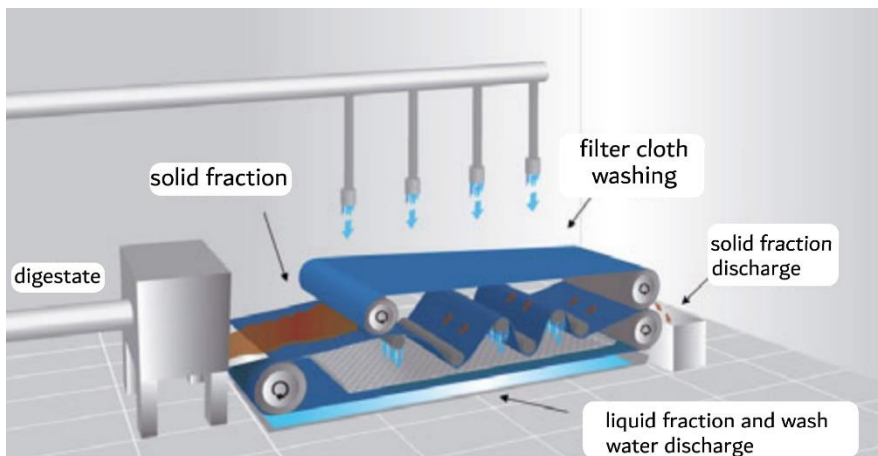

Figure 2-9 Scheme of a belt press, source: adapted from (Hjorth et al. 2010)

### 2.2.1.3.2 Separation efficiency

None of the Demo Plants or Outreach Locations have a belt press implemented. Table 2-13 gives data for separation efficiencies from 2 Associated plants and data from the database.

Digestate treated in a belt press usually needs to be **conditioned with poly electrolytes** (polymers/flocculants) for efficient dewatering.

*Table 2-13 Summary of separation efficiencies of belt presses to the solid fraction of different parameters from the SYSTEMIC plants and the SYSTEMIC database.*

Separation efficiency SF %	Mass	DM	OM	Total N	NH <sub>4</sub> -N	Total P	Total K
<sup>1</sup> Associated Plant	20						
<sup>2</sup> Associated Plant	27						
<sup>3</sup> Associated Plant	23						
<sup>4</sup> Database	27±3	66±1	73	32	28	48±26	26±1

<sup>1</sup> Associated Plant in Belgium: feedstock 90 kt/year:61% pig manure, 39% other organic biological waste  
81kt/year is separated in the belt press. Flocculants are added to the belt press. Estimations of recovery rate based on operator knowledge.

<sup>2</sup> Associated Plant in Belgium: feedstock 250 kt/year:50% pig manure, 50% other organic biological waste.  
Estimation by technology provider based on 250kt/year digestate of 10.5% DM. Digestate is first separated in a flotation unit, where flocculants added. The solid fraction from the flotation unit is dewatered in a belt press without additional flocculants.

<sup>3</sup> Associated Plant in Belgium: feedstock 250 kt/year:100% pig manure,  
Estimation by technology provider based on 250kt/year digestate of 8.5% DM. Digestate is first separated in a flotation unit, where flocculants added. The solid fraction from the flotation unit is dewatered in a belt press without additional flocculants.

<sup>4</sup> SYSTEMIC database (December 2020): filtered on Type of input: "digestate", end product: "solid fraction", after: "separation-belt press"  
Average SE ± Stdev.P; mass(n=3) , DM (n=2), OM (n=1), Total N (n=2),NH<sub>4</sub>-N(n=1), Total P(n=4), Total K (n=2)



**Combination with other techniques** (e.g. pre-treatment) was seen in the the Associated plant BioStorg, where a flotation unit is used as a first dewatering step of the digestate. According to the technology supplier VP-Hobe, this lowers the use of flocculants in both steps and increases the efficiency of the belt press.

#### **Composition of the end products**

According to the SYSTEMIC database, a solid fraction of digestate after a belt press has an average DM percentage of  $23\pm 3$  (n=5). More details on products can be found in the SYSTEMIC product fact sheets.

#### **Treatment capacity**

The relation of the treating capacity of the belt press with the SE was not investigated further, due to lack of data. But it is assumed that all belt presses (large or small) have equal performance.

##### ***2.2.1.3.3 Energy requirements***

The energy consumption of the belt press at the Associated Plants was not individually measured or calculated.

Other values are found in the database, describing belt presses with an average electrical energy consumption  $\pm \text{Stdev.P}$  of  $0.9\pm 1.3 \text{ kWh/m}^3$  digestate (n=13). Due to the lack of data and details in the data, the accurateness of these values is uncertain.

No heat is required for operating a belt press.

##### ***2.2.1.3.4 Storage capacity***

A belt press treating up to 20 tons/h requires a surface about 15-20m<sup>2</sup>. Storage capacity for the produced liquid and solid fraction can be calculated based on the treated volumes and separation efficiency.

##### ***2.2.1.3.5 Costs***

**The capital expenditures (CAPEX)** are the investment costs. Table 2-14 gives some values for CAPEX of a belt press in relation to the treatment capacity.

Table 2-14 CAPEX vs treatment capacity of a belt press (SYSTEMIC database, December 2020)

Treatment capacity (ton/h)	CAPEX (€)	n
	Average ±Stdev.P	
2	107,500±40,697	6
3	70,000	1
4	70,000	1
5	106,666±48,362	6
10	112,500±37,500	2
20	125,000±50,000	2
40	112,500±37,500	2

The large variances can be attributed to the fact that some CAPEX data contain also the costs for installation of the technology and programming of the Programmable Logic Controller (PLC). These extra costs are not always specified, so a 'clean' figure for the cost of only a screw press was not possible to obtain.

Data from the SYSTEMIC database, based on a.o. (Bamelis 2016; Evers et al. 2010; Lemmens et al. 2020; Postma et al. 2013; STIM and VCM 2004; Verdoes 2013) and personal communication with consultants and technology suppliers like Nijhuis and DLV-United Experts.

A polymer dosing unit is estimated to cost between 12.000 and 50.000€ (Bamelis 2016) and one is needed per belt press.

**The operational expenditures (OPEX, here considered as the pure processing cost,** can include various costs like equipment maintenance costs, costs of chemicals and additives and labour costs.

If OPEX data was found, it generally an estimation on a yearly base, which was often reported as a percentage of the CAPEX (Table 2-15).

Table 2-15 Data on the OPEX of a belt press from the SYSTEMIC database, December 2020.

Source	OPEX	Remarks
(Evers et al. 2010)	17.8%	Based on 5% interest, 10% depreciation, 5% maintenance en 10% residual value
(Bamelis 2016)	5-10€/ton digestate	Cost breakdown not specified
(Lemmens et al. 2020)	3.25€/m <sup>3</sup> manure	Cost breakdown not specified
(Postma et al. 2013)	5%	Cost breakdown not specified
Personal communication technology provider, 2020	0.30 €/ton 0.35 €/ton	250.000 ton/year maintenance PLC automatisaton

The large variation can be attributed to the fact that it was also not always clear which cost items were included in this percentage.

### **Energy costs**

The default price used for electricity is 0.02-0.15€/kWh

The costs for energy could then be estimated at  $0.09 \pm 0.1 \text{ €/m}^3$  ( $0.9 \pm 1.3 \text{ kWh/m}^3 * 0.1 \text{ €/kWh}$ ).

### **Cost of chemicals**

Based on data from suppliers and biogas plants polymers can cost between 2.5-3.5 €/kg.

Amounts of polymer added varied between 9 kg polymer/kg DM (GEA separation excel tool) and >14(Bamelis 2016).

However, the amounts can vary depending on the type of digestate and the finetuning of the separation with polymer addition.

## 2.2.1.4 Dissolved Air Flotation (DAF)

### 2.2.1.4.1 Technology description

A flotation system is mainly used as an additional separation step, to remove suspended solids, oil, fats and grease and other apolar substances from liquid fraction (Gruwez 2012) (Figure 2-10). It is a gravity separation process based on the attachment of air or gasses bubbles to solid particles, which are then carried to the liquid surface where they form a crust, which can be scraped off (Lebuf et al. 2013).



Figure 2-10 Scheme of a Dissolved air flotation (DAF), source: adapted from Nijhuis Industries.

Depending on the way the gas bubbles are generated, flotation is divided into dispersed air, dissolved air and electrolytic air.

The Dissolved Air Flotation (DAF) is the most diffused flotation system. By decompressing compressed air, very small air bubbles are created, which are released on the bottom of the tank. In order to improve the separation efficiency, coagulating and/or flocculating agents can be added to input stream. Complexing agents like  $\text{FeCl}_3$ ,  $\text{Fe}_2(\text{SO}_4)_3$ , organic coagulants, etc. are used to coagulate the solid particles, fats and grease. Polymer is added to flocculate the created complexes which can be removed at the surface.

Treatment capacity ranges from  $0.1\text{m}^3/\text{h}$  to more than  $1000\text{m}^3/\text{h}$ .

### 2.2.1.4.2 Separation efficiency

Table 2-16 gives data for separation efficiencies from Groot Zevert Vergisting and data from the database.

Digestate treated in a DAF unit usually needs to be **conditioned with coagulants and/or flocculants** for efficient dewatering.

*Table 2-16 Analyses on digestate and related DAF separation efficiency to the solid fraction of different parameters from monitoring campaigns during the SYSTEMIC project at Groot Zevert Vergisting.*

*DMsus = suspended dry matter, DMsol = soluble dry matter, OM = organic matter, Total N = total nitrogen, NH<sub>4</sub>-N = ammonium nitrogen, Org-N = organic nitrogen, Total P = total phosphorus, Inorg-P= inorganic phosphorus, Org-P= organic phosphorus, Total K = total potassium, DC= decanter centrifuge, LF = liquid fraction, SF=solid fraction, PM= powder polymer*

		LF after DC	Separation efficiency SF %	<sup>2</sup> LF after DC	Separation efficiency SF %	<sup>3</sup> Mixture storage 102	Separation efficiency SF %
Mass	Ton day <sup>-1</sup>		24	292	31		19
Water	g kg <sup>-1</sup>	871	24				
DMsus	g kg <sup>-1</sup>	11	60			14	42
DMsol	g kg <sup>-1</sup>	20.3	24				
OM	g kg <sup>-1</sup>	5.8	60				
Total N	g kg <sup>-1</sup>	5.6	26	6.2	21	2.6	26
NH <sub>4</sub> -N	g kg <sup>-1</sup>	5.1	24	4.4	25	2.3	19
Org-N	g kg <sup>-1</sup>	0.6	45				
Total P	g kg <sup>-1</sup>	0.3	70	0.6	35	0.036	17
Inorg-P	g kg <sup>-1</sup>	0.26	70				
Org-P	g kg <sup>-1</sup>	0.04	70				
Total K	g kg <sup>-1</sup>	4.48	24	4.4	23	2.1	18

<sup>1</sup> GZV 115kt feedstock per year: 64% pig slurry, 4% cattle slurry, 10.5% slaughterhouse manure, 18% Co-product dairy industry, 2.6% glycerine (Brienza et al. 2018) calculated and estimated figures by Nijhuis Industries, Polymer addition 0.063 kg PM/ton input

<sup>2</sup> GZV 112kt feedstock per year: 67% pig slurry, 4.5% cattle slurry, 9% slaughterhouse manure, 16% Co-product dairy industry, 3.5% glycerine (Brienza et al. 2019) April 24th and May 7th 2019 average of samples taken (n=2) . Polymer added

<sup>3</sup> AM-Power 121kt/year: 88% food industry waste, 9% glycerine, 2% organic biological waste (Brienza et al. 2018) September-October 2018 average of samples taken (n=2) . Polymer added

Table 2-17 Summary of separation efficiencies of DAF units to the solid fraction of different parameters from the SYSTEMIC plants and the SYSTEMIC database.

Separation efficiency SF %	Mass	DM	OM	Total N	NH <sub>4</sub> -N	Total P	Total K
<sup>1</sup> GZV	24-31	36	60	21-26	24-25	35-70	23-24
<sup>2</sup> AM-Power	19	42		26	19	17	18
<sup>4</sup> Database	58±8			34±1		92±4	

<sup>1</sup> Summary of the data from GZV in Table 2-16 ;minimum-maximum

<sup>2</sup> Summary of the data from AM-Power in Table 2-16

<sup>3</sup> SYSTEMIC database (December 2020): filtered on Type of input: "digestate", end product: "solid fraction", after: " separation-DAF"

Average SE ±Stdev.P; mass(n=3) , DM (n=0), OM (n=0), Total N (n=3),NH<sub>4</sub>-N(n=0), Total P(n=3), Total K (n=0)

### Combination with other techniques

The effect of pre-treatment could not be investigated due to lack of data.

### Composition of the end products

The resulting solid fraction from a DAF will have a relatively high moisture content (3 to 8% DM)(Cocolo 2012). Values from the Demo Plants (Brienza et al. 2019) and the SYSTEMIC database show a large variation (3.2-32%DM) due to different types of of input material (digestates, manures, LF of DAF after centrifuge, screw press or belt press) or sampling method.

### Treatment capacity

The relation of the treating capacity of the DAF with the SE was not investigated further, due to lack of data. But it is assumed that all DAF units (large or small) have equal performance.

#### 2.2.1.4.3 Energy requirements

The energy consumption of the DAF unit at GZV was 0.45kWh/m<sup>3</sup> input. AT the AM-Power plant, the DAF had an electrical power capacity of 7kWe. Here, the energy consumption per m<sup>3</sup> of digestate was not individually measured or could calculated for the DAF unit at the time (Brienza et al. 2019).

Other values are found in the database, describing DAF units with a power capacity ranging from 2-4 kWe. An estimation of 1.36 kWh/m<sup>3</sup> digestate was provided by Rika Biofuels. No heat is required for operating a DAF unit.

#### 2.2.1.4.4 Storage capacity

A DAF treating 25 m<sup>3</sup>/h requires a surface about 15-30m<sup>2</sup>. The DAF unit can also be located outside. Storage capacity for the produced liquid and solid fraction can be calculated based on the treated volumes and separation efficiency.

#### 2.2.1.4.5 Costs

**The capital expenditures (CAPEX)** are the investment costs. Table 2-18 gives some values for CAPEX of a screw press in relation to the treatment capacity.

*Table 2-18 CAPEX vs treatment capacity of a DAF (SYSTEMIC database, December 2020)*

Treatment capacity (ton/h)	CAPEX (€)	n
	Average ±Stdev.P	
15	375,760	1
22	500,000	1
70	55,000±20,000	2
75	49,000±8981	3
80	55,000±20,000	2

The large variances can be attributed to the fact that some CAPEX data contain also the costs for installation of the technology and programming of the Programmable Logic Controller (PLC). These extra costs are not always specified, so a 'clean' figure for the cost of only a DAF was not possible to obtain.

Data from the SYSTEMIC database, based on personal communication with consultants and technology suppliers like Rika Biofuels.

A polymer dosing unit is estimated to cost between 12.000 and 50.000€ (Bamelis 2016) and one is needed per DAF unit.

**The operational expenditures (OPEX, here considered as the pure processing cost,** can include various costs like equipment maintenance costs, costs of chemicals and additives and labour costs.

Yearly maintenance costs of the DAF at Groot Zevert Vergisting has been estimated at around 1% of investment (Brienza et al. 2018).

## **Cost of chemicals**

The amount of coagulant and flocculant that is used, depends on the amount of solids and grease in the input, and the separation efficiency that is desired. However, there is a certain maximum amount of flocculant added, after which the separation efficiency will not improve anymore (Cocolo 2012; Prodănescu 2017).

Based on data from suppliers and biogas plants polymers can cost between 2.5-3.5 €/kg. FeCl<sub>3</sub>(40%) is has an average price of 0.15€/kg. Amounts of polymer dosed in a DAF ranges from 0.06 kg polymer per m<sup>3</sup> of digestate (GZV, (Brienza et al. 2018) to 0.3 kg polymer/ton input (Hoeksma and De Buissonjé 2011).

However, the amounts can vary depending on the type of digestate and the finetuning of the separation with polymer addition. AM-Power used a combination of to 0.3 kg polymer/m<sup>3</sup> input (46L 0.7% polymer solution/m<sup>3</sup> input) in combination with 3.5L FeCl<sub>3</sub> (40%) /ton (AM-Power 2017-2018). This was added before the centrifuge so the additives improved the performance of both the centrifuge and the DAF.

This would result respectively for polymer and FeCl<sub>3</sub> in 0.9€/m<sup>3</sup> of input (0.3kg PM/m<sup>3</sup> input \* 3€/kg PM) and 0.35€/m<sup>3</sup> input (3.5 L /m<sup>3</sup> input \* 0.10€/L, density: 1.438L/kg)

### 2.2.1.5 Comparison separation efficiency different types of separators

Mechanical separation is known to be inefficient for concentrating components that are mostly water-soluble or present as/ adsorbed to small particles. In digestates, it is not only the case of K and NH<sub>4</sub>-N thus TN, but also Na, S, Cu, and Zn (Cocolo 2012; Guilayn et al. 2019).

Screw presses tend to have lower efficiency for separation of minerals (N, P, K) and only efficient with digestates with lower moisture inputs (> 4% DM) presenting containing large particles such as manure and silage lignocellulosic fibres (personal communication technology supplier, 2020; Guilayn et al. 2019).

The opposite is the case for decanter centrifuges. A digestate with a high N-org content would tend to generate an NP-rich solid fraction (Guilayn et al. 2019).

However coarse particles mainly get degraded during anaerobic digestion and are therefore not retained, resulting in a low SE Total DM for digestate



in a screw press (SE DM centrifuge  $59 \pm 17$ ; SE DM screw press  $33 \pm 14$ )(Table 2-4, Table 2-10, Masse et al. 2005)

Regarding the separation of larger particles, decanting centrifuges might be damaged by gross material and are more effective to remove small suspended particles, especially after coagulation. At the same time, the higher investment costs make that the economic feasibility of centrifuges needs much higher flows, which is commonly not the case of farm-based AD plants but it is true for industrial, municipal and other centralized facilities. In general, a centrifuge can separate particles as low as  $2 - 5 \mu\text{m}$ , which contributes to a relatively high separation efficiency for phosphorus, compared to a screw press (SE P centrifuge  $76 \pm 18$ ; SE P screw press  $28 \pm 11$ )(Table 2-4, Table 2-10; SYSTEMIC Biogas Plant, internal communication, 2020; Guilayn et al., 2019).

The advantage of the centrifuge lies in the fact that it combines high efficiency with automatization. The investment cost is higher than a screw press and belt press, and has a higher energy use. The high rotation frequency and friction creates wear and tear, which contributes to higher operational costs.

Belt presses produce a solid fraction with a lower dry matter content than a centrifuge, however the SE P is comparable. Belt presses are relatively expensive and therefore more suitable for collective or regional application. Disadvantages of the belt press are the use of wash water for the belt and the coagulants and flocculants to obtain a sufficiently high SE P(VLM 2018).

The best-fit technology for a particular case depends on the goal that needs to be achieved: high P recovery or DM recovery, at a low cost or not, etc. For example, a screw press in series with a centrifuge working at relatively low flow rates ( $4.5 \text{ m}^3/\text{h}$ ) could provide higher N and P recoveries (45–80%) but at considerable expenses ( $3.68\text{€}/\text{m}^3$ ;  $4.43\text{€}/\text{kg P}$  and  $2.34\text{€}/\text{kg N}$ ) while a run-down screen screw press system working at high flows ( $18\text{m}^3/\text{h}$ ) could achieve P and N recoveries of 20 and 15% respectively with lower operational costs ( $1.03\text{€}/\text{m}^3$ ;  $4.96\text{€}/\text{kg P}$  and  $1.96\text{€}/\text{kg N}$ ) (Romero Güiza et al. 2016).

## 2.2.2 Ammonia stripping-scrubbing

### 2.2.2.1 Technology description

The ammonia stripping-scrubbing technique can be applied on a nitrogen (N) rich waste stream, such as (liquid fraction) of digestate.

A solution like (liquid fraction of) digestate, contains anhydrous ammonia dissolved in water, in which the ammonium ion in solution exists in equilibrium with unionized (free) ammonia, which can volatilize.

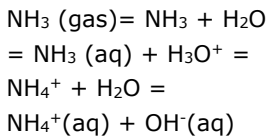

This equilibrium or the “urge to escape as a gas or stay in solution” depends on pH and temperature [2].

Increasing pH and/or temperature pushes the equilibrium from soluble ammonium ( $\text{NH}_4^+$ ) towards gaseous strippable ammonia. The partial pressure of  $\text{NH}_3$  will also rise with the falling pressure (when working under vacuum conditions).

#### pH increase and temperature increase

In the first step, the liquid fraction is manipulated to ensure that more nitrogen becomes available in the form of ammoniacal nitrogen ( $\text{NH}_3\text{-N}$ ) as only this form of gaseous nitrogen can be recovered. This can be done either by increasing the pH with caustic lime ( $\text{Ca}(\text{OH})_2$ ) or by sodium hydroxide ( $\text{NaOH}$ ).

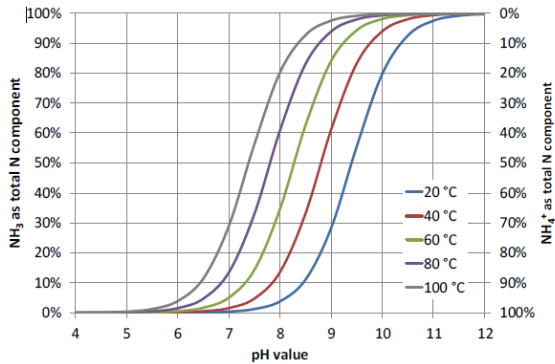

Figure 2-11: Equilibrium of  $\text{NH}_3$  and  $\text{NH}_4^+$  in water at different pH and different temperatures

<sup>2</sup>The base ionization constant is  $K_b = 1.8 \times 10^{-5}$  and within the temperature range of  $0^\circ\text{C}$ – $50^\circ\text{C}$  and a pH range of 6.0 to 10.0, the relation with temperature is  $\text{p}K_a = 0.0901821 + 2729.92/\text{Tk}$  where Tk is temperature in degrees Kelvin,  $\text{Tk} = ^\circ\text{C} + 273.2$ .

NaOH consumption can be decreased or avoided when the excess carbonate buffer capacity in the input is removed. This can be achieved by stripping CO<sub>2</sub> from the input, which will also prevent the formation of CaCO<sub>3</sub> precipitates in the N stripper (Vaneekhaute 2015).

### Ammonia stripping

Next, the liquid fraction enters on top of the system, where it is diffused by nozzles or sprayed over a packing material to increase the contact surface of liquid and air. The stripping gas enters usually from the bottom. In this way ammonia is transferred from the liquid to the gaseous phase in a counter current system.

### Ammonia scrubbing

The stripping gas, charged with ammonia, is then captured and the ammonia is removed (scrubbed) by washing it with a strong acidic solution, such as sulphuric acid or nitric acid, in the scrubbing system. The scrubber water, is an ammonium salt solution of ammonium sulphate or ammonium nitrate, which can be used as an alternative crop fertiliser (see D 3.4 Market Research in Europe).

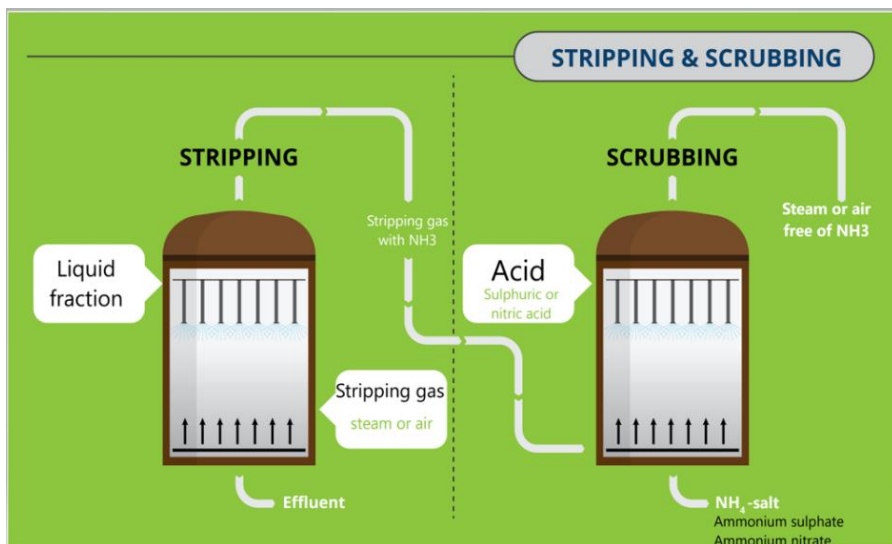
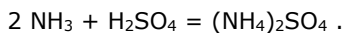

Figure 2-12 Scheme of N stripping-scrubbing. Adapted from: Intereg Flanders-the Netherlands project NITROMAN. [www.nitroman.be](http://www.nitroman.be)

Alternatively, the stripping gas, containing NH<sub>3</sub>, CO<sub>2</sub> and H<sub>2</sub>O is brought into contact with gypsum and reacts to calcium carbonate, which is precipitated, and ammonium sulphate as solution.



The stripping gas from which the ammonia is removed can be recirculated to the stripping tower.

As stripping and scrubbing of ammonia occurs in a closed system, emissions are generally low. Obviously, non-volatile components, like organic-bound N, phosphorus, potassium, metals, solids etc. will not be transferred to the ammonium sulphate/nitrate solution, but will stay in the stripper effluent.

### **Configuration: Inline stripping**

Some feedstock (such as poultry manure, protein-rich feedstock) have relatively a high N content, which may cause high concentrations of ammonia to be released in the digester during anaerobic digestion. When reaching toxic concentrations, this can cause inhibition of the Archaea and lower biogas production (Kratat et al. 2017; SYSTEMIC et al. 2018). Recirculation of N-depleted digestate after N stripping to the AD has proven to be effective in diluting ammonia concentrations within the digester. At the same time, ammonia is recovered in the form of ammonium sulphate solution (Ghyselbrecht et al. 2017).

When stripping with air, the oxygen in the stripping gas can also lower the activity of the anaerobic bacteria and therefore stripping with biogas can lead to higher biogas production (Bousek et al. 2016; VCM 2018a). Within the SYSTEMIC project, Acqua & Sole (Italy) and Benas (Germany) have implemented their AD plants with an inline N-stripper to reduce the NH<sub>3</sub> concentration in the digester during the digestion process (Figure 2-13). Acqua & Sole relies on H<sub>2</sub>SO<sub>4</sub> solution as scrubbing agent (sulphuric acid approach), therefore NH<sub>3</sub> is recovered in the form of ammonium sulphate. Conversely, Benas has implemented the FiberPlus ammonia stripping-scrubbing system (formerly known as ANAStrip), designed by GNS. It is an innovative approach on the N stripping-scrubbing technology where CaSO<sub>4</sub>.2H<sub>2</sub>O (Flue gas desulphurisation gypsum) is used to produce a suspension of ammonium sulphate and a liming product containing CaCO<sub>3</sub>(gypsum approach). These two are separated by means of a chamber filter press.

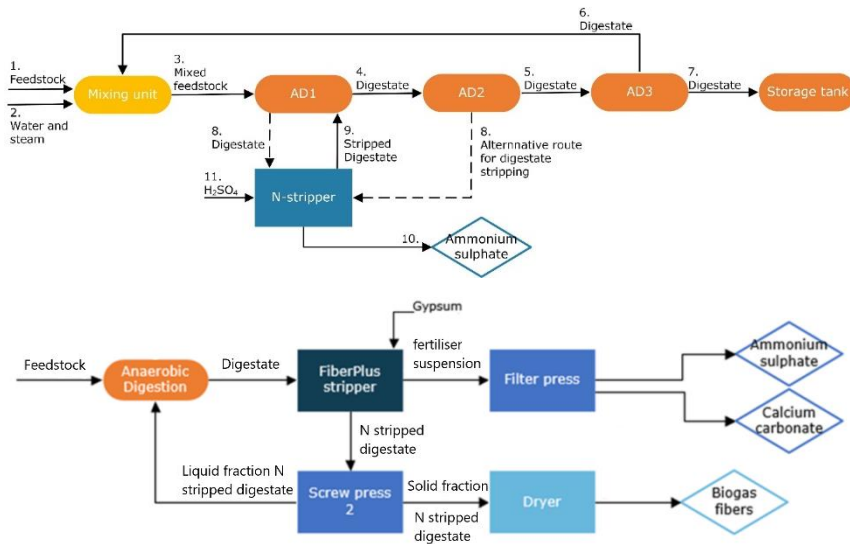

Figure 2-13 Scheme inline ammonia stripping-scrubbing from digestate at *Acqua e Sole* (cascade on top), and *Benas* (cascade below)

### Configuration: End of pipe stripping

Ammonia stripping-scrubbing can also be useful before or after biological treatment (nitrification-denitrification), when focussing on lowering and recovering the nitrogen of the digestate for marketing reasons (f.e. low N fertilising application limits in nitrate vulnerable zones).

#### 2.2.2.2 Recovery efficiency

The efficiency of  $\text{NH}_3$  stripping is dominated by multiple parameters, e.g.  $\text{NH}_4^+$  concentration, buffer capacity, mass transfer surface area (packing), temperature, pH, retention time, as well as the flow rates of gas and liquid in the stripping towers (Shi et al. 2018).

The N recovery efficiency from a stripper-scrubber combination can range from 20% to theoretically 98%, since the recovery efficiency can be controlled by using adapting pH and temperature and recirculating the scrubber solution until it is saturated (Vaneekhaute et al. 2017). However, 80–90% is usually achieved in an effort to cut down the expenses (Barampouti et al. 2020; Vaneekhaute 2015). The choice of how much nitrogen is eventually stripped, will be case specific. Table 2-19 gives some

examples of digestates from the Demo plants with the respective recovery rate for mass, and nitrogen to the ammonium sulphate solution.

### **NH<sub>4</sub><sup>+</sup> input concentration**

N recovery using air stripping-scrubbing only becomes economically feasible at input concentrations in the range of 400-500 mg N/L (Vaneckhaute 2015).

When using inline N stripping, a balance has to be made: strip enough nitrogen to prevent ammonia toxicity in the digester but prevent stripping too much and having a larger acid consumption (e.g. H<sub>2</sub>SO<sub>4</sub>). Table 2-19 gives the obtained recovery rate and products at Demo Plant Acqua e Sole.

### **pH, T, air flow**

The efficiency of NH<sub>3</sub> stripping is governed mostly by pH and temperature and air flow, where pH will have the largest influence (Barampouti et al. 2020; Guštin and Marinšek-Logar 2011; Shi et al. 2018).

For optimal ammonia removal, the pH of the liquid fraction should be around 10-11 and the temperature around 70°C (Emerson et al. 1975; Lemmens et al. 2020; Monfet, Aubry, and Ramirez 2018).

However, at 80 °C, the ammonia nitrogen could be fully recovered independently of pH (Bonmatí and Flotats 2002).

Increasing the temperature increases the NH<sub>3</sub> stripping performance. The more NH<sub>3</sub> is stripped out, the lower the effluent pH (Vaneckhaute 2015).

Table 2-20 gives an overview of different operational conditions (pH, temperature, flow rate) and the resulting recovery rates for N.

### **Addition of chemicals**

The **amount of alkali** -caustic lime (Ca(OH)<sub>2</sub>), sodium hydroxide (NaOH), magnesium hydroxide (Ca(OH)<sub>2</sub>) or lime (CaO)- needed to increase the pH towards 10-11 is determined by the **buffer capacity** of the digestate entering the stripper.

The buffer capacity of the digestate at pH 8 is mainly due to the carbonate alkalinity (i.e. ions HCO<sub>3</sub><sup>-</sup>) and H<sub>2</sub>PO<sub>4</sub><sup>-</sup>. The latter only contributes to a smaller degree as the concentration of H<sub>2</sub>PO<sub>4</sub><sup>-</sup> is lower compared to HCO<sub>3</sub><sup>-</sup> (Errico et al. 2018).

NaOH consumption can be decreased or avoided by removing a part of this carbonate buffer by stripping CO<sub>2</sub> from the input, increasing the pH. This will shift the NH<sub>4</sub><sup>+</sup>/NH<sub>3</sub> ratio towards strippable ammonia (Figure 2-11), hereby increasing the N recovery efficiency.

Table 2-19 Analyses on digestate, AS and stripped digestate and related NH4-N recovery rate of different parameters from monitoring campaigns during the SYSTEMIC project at Acqua e sole and Benas.

DM = dry matter, OM = organic matter, Total N = total nitrogen, NH4-N = ammonium nitrogen, , Total P = total phosphorus, Total K = total potassium, Total S = total sulphur, AS = ammonium sulphate solution

	Mass	pH	DM	OM	Total N	Recovery rate N (%)	NH4-N	Recovery rate NH4-N (%)	Total P	Total K	Total S
	Ton day <sup>-1</sup>		g kg <sup>-1</sup>	g kg <sup>-1</sup>	g kg <sup>-1</sup>		g kg <sup>-1</sup>		g kg <sup>-1</sup>	g kg <sup>-1</sup>	g kg <sup>-1</sup>
<sup>1</sup> AS	2.3	6.7	318		74	9	74		0.02	0.02	97.6
<sup>2</sup> AS	2.4	6.0	363		74	9	74		0.011	0.012	
<sup>3</sup> AS	2.3	6.9	372		73	10	73	22	0.013	0.013	92
<sup>4</sup> AS		7.2	351		76	8.7	73		0.0091	0.008	82
<sup>5</sup> digestate N	229.4	8.3	127	85	7.7		3.8		2.25	7.3	0.75
stripped digestate N	219	9.3	124.4	86	6.2	77	0.7	80	2.3	7.8	0.71
AS	11.1	7.7	250	0	53	33	53	67			60
<sup>6</sup> digestate N		8.5	119	82	8.2		4.5		1.8	7.1	1.2
stripped digestate N		9.9	126	86	5.8		1.8		1.9	7.7	1.3
AS		7.8	224		46	31	46	57	0.0033	58	0.0039
<sup>7</sup> digestate N		8	86		6.5				1.2	5.5	0.94
stripped digestate N		9.7	88		5.1				1.2	5.5	
AS		7.8			45				0.000023	0.014	

<sup>1</sup> Acqua e Sole: 14.1kt feedstock per year: 92% Sewage sludge WWTP, 3% Digestate form anaerobic treatment of segregated solid food waste (SSFW), 4% Liquid fraction of SSFW  
(Brienza et al. 2018) sampling period 14 January – 8 April 2018 , average. Input of the stripper: 240 ton/day; H<sub>2</sub>SO<sub>4</sub> (50%) 5.4kg/ton input

<sup>2</sup>Acqua e Sole: 55kt feedstock per year: 95% Sewage sludge WWTP, 3.5% Digestate form anaerobic treatment of segregated solid food waste (SSFW), 1.5% Liquid fraction of SSFW  
(Brienza et al. 2019)sampling period January 2018 - March 2019, excluding August – December 2018 , average (n=2) Input of the stripper: 240 ton/day; H<sub>2</sub>SO<sub>4</sub> (50%) 8.7 kg/ton input

<sup>3</sup>Acqua e Sole: 33.7kt feedstock per year: 90% Sewage sludge WWTP, 2.5% Digestate form anaerobic treatment of segregated solid food waste (SSFW), 3% Liquid fraction of SSFW, 4.5% agro-food waste  
(Brienza et al. 2020) sampling period January 2018 – July 2018, average (n=2) Input of the stripper: 240 ton/day; H<sub>2</sub>SO<sub>4</sub> (50%) 9.1 kg/ton input

<sup>4</sup>Acqua e Sole: 69 kt feedstock per year: 84% Sewage sludge WWTP, 4.6% Digestate form anaerobic treatment of segregated solid food waste (SSFW), 11.3% agro-food waste  
(Brienza et al. 2020)sampling period January 2019 – October 2019, average (n=27)

<sup>5</sup>Benas: 9.58 kt feedstock per year: 35% Chicken manure, 30% Rye silage, 28% Corn silage, 4.6% Grain flour, 2.6% Grass silage  
(Brienza et al. 2018) sampling period August 2017, average (n=) FDG Gypsum: 19.2 kg/ton input

<sup>6</sup>Benas: 28.2 kt feedstock per year: 28% Chicken manure, 0.8% Goose manure, 62% Corn silage, 3% Corn grain, 5.3% Grass silage, 0.8% millet  
(Brienza et al. 2020) sampling period January – April 2019, average (n=12) FDG Gypsum: 19.2 kg/ton input

<sup>7</sup>Benas: (Brienza et al. 2020) sampling period February-March 2020, average (n=3) FDG Gypsum: 19.2 kg/ton input



Table 2-20 N recovery rates from literature and the systemic database with the corresponding system operation conditions.

	<b>Input</b>	<b>Temperature</b>	<b>Air flow</b>	<b>pH</b>	<b>NH<sub>3</sub> recovery rate (%)</b>
(Laureni et al. 2013)	raw digestate	50°C	lower air consumption	pH 8.5 and 9.5	80% and 95%
(Guštin and Marinšek-Logar 2011)	liquid fraction of digestate	50°C	elevated air consumption	pH 10.5	93%
(Guo et al. 2010)	digestate			8	80
(Guo et al. 2010)	digestate			11	92%
(Bonmatí and Flotats 2002)	digestate	80°C		pH 9.5	87%
(David Fangueiro et al. 2017)	digestate	20°C		12–12.5	80–90%
(Hallbar Consulting n.d.)	digestate			No alkali or stripping towers	40-50%
<sup>1</sup> database	digestate				76±10%

<sup>1</sup> SYSTEMIC database (December 2020): filtered on Type of input: "digestate", end product: "ammonium sulphate solution", after: "+stripping-scrubbing"

Temperature and pH not specified. Average SE ±Stdev.P; NH<sub>4</sub>-N(n=4)

Usually the digestate alkalinity (4,000-6,000 mg L<sup>-1</sup> as CaCO<sub>3</sub>) is sufficient to satisfy the pH requirements by stripping out CO<sub>2</sub>, without the use of chemicals. In this case, it is interesting to select a stripping process without packing column in order to avoid CaCO<sub>3</sub> precipitation on the packing (Vaneekhaute 2015).

The pH increase configuration of the N stripping-scrubbing unit (i.e. chemical addition or CO<sub>2</sub> stripping) will also have an influence on the investment and operational costs (see 2.2.2.5).

The **addition of acid** ( $H_2SO_4$  or  $HNO_3$ ) or gypsum as scrubber reagent depends on the desired  $NH_3$  removal efficiency, i.e. the amount of ammonia that needs to be scrubbed from the  $NH_3$  stripping gas.

This is determined by measuring indirectly the ammonia concentration of the scrubber water or in the stripping gas by means of pH, density and electrical conductivity.

The FiberPlus system works with gypsum ( $CaSO_4 \cdot 2H_2O$ , ca. 172 g/kg) as a scrubbing agent. The gypsum used for the process is a by-product of Flue Gas Desulphurisation (FGD) in coal power plants, and is certificated by the REACH regulation.

### Combination with other technologies (Pre- and post-treatment

The most common design of  $NH_3$  stripper/scrubbers are packed towers, having a low surface footprint but in practice they are easily fouled when input steam contains a lot of suspended solids or fibres. Total suspended solid levels (TSS) > 2 % must usually be removed using a solid-liquid phase separation unit prior to stripping to prevent a decreased stripping performance. Nonetheless, it is unavoidable that the packing material will have to be cleaned periodically (Vaneckhaute 2015).

Alternative technologies have been developed to overcome this problem, by removing the packing material and optimize a liquid diffuser system. These systems would be capable of handling liquid flows containing up to 8-9 % total suspended solids (TSS), without addition of any chemicals. However, they require multiple vessels with diffuser systems in series to reach a maximal ammonia mass transfer area (communication with technology providers, 2020; Barampouti et al. 2020).

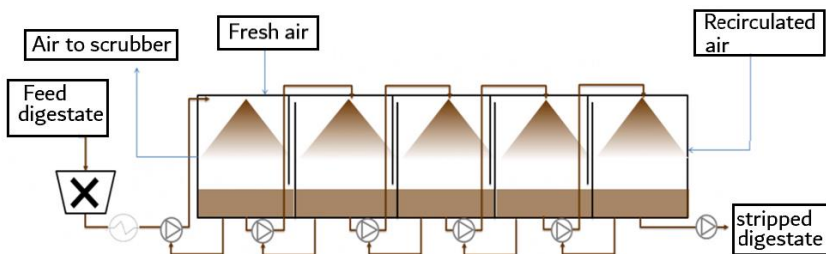

Figure 2-14 Configuration of  $NH_3$  stripping-scrubbing on manure or digestate without packing tower. Source: AMFER, Colsen.

Scaling is also common when stripping  $\text{NH}_3$  from digestate (Limoli, Langone, and Andreottola 2016). At high stripping temperatures dissolved magnesium or calcium -sulfate, -chloride, or -carbonates can precipitate and form solid deposits. This can be prevented by increasing the pH by adding  $\text{CaO}$ ,  $\text{Mg}(\text{OH})_2$  slurry,  $\text{Na}_2\text{CO}_3$  or stripping the carbonates out as  $\text{CO}_2$  (Barampouti et al. 2020). Increasing the liquid flow rate, reduces the residence time in the system. As such, the (slow) formation of  $\text{CaCO}_3$  precipitates in the reactor is reduced, and thus also the scaling potential (Vaneckhaute 2015).

High levels of chlorides in the input ( $> 20 \text{ mol/m}^3$ ) could lower the  $\text{NH}_3$  removal rate ( $\leq 50\%$ ). Ion exchange or sorption could remove these chlorides prior to stripping (Vaneckhaute 2015).

If the concentration of the ammonium sulphate solution rises above 40%, crystals can form which can cause blockage of the spraying system in the scrubber. Therefore, the ammonium sulphate solution needs to be diluted with water to avoid reaching these concentrations in the reactor.

### **Composition of the end products**

The acidic solution used to wash the ammonia ( $\text{NH}_3$ ) from the air is usually sulphuric acid ( $\text{H}_2\text{SO}_4$ ). A chemical reaction creates an ammonium sulphate ( $(\text{NH}_4)_2\text{SO}_4$ ) solution.

Similar to synthetic produced mineral N fertilisers, ammonium sulphate solution contains N entirely in mineral form, as  $\text{NH}_4\text{-N}$ . When the product is obtained by means of sulphuric acid, ammonium sulphate solution is also an important source of sulphur (S). Nonetheless, the ratio N/S found in the scrubber fluid can differ from the actual N/S ratio required for the crop which could therefore lead to S over-fertilisation. This constraint is not encountered when working with  $\text{NH}_4\text{NO}_3$  scrubber waters (EIP-AGRI Focus Group 2017).

Alternatively, nitric acid ( $\text{HNO}_3$ ) can also be used as scrubbing acid, which reaction with ammonia would produce ammonium nitrate. The cost of nitric acid is higher, but the N content of the end product is higher (up to 18 mass% N), and a neutral pH-value gives it a higher market potential (Digesmart 2016).

According to the SYSTEMIC database, the N concentration of the obtained ammonium sulphate solution is on average  $63 \pm 14 \text{g N/kg}$  ( $n=13$ ).

The average N concentration in ammonium nitrate after N stripping-scrubbing of liquid fraction of digestate from animal origin ranges from 132-198g Total N/kg and 76-109g  $\text{NH}_4\text{-N/kg}$  (SYSTEMIC Fact Sheet ammonium nitrate, 2021).

More details on products can be found in the SYSTEMIC product fact sheets.

Next to ammonium sulphate solution produces the FiberPlus system a **calcium carbonate slurry** (70% DM), which can be separated from the ammonium sulphate solution with a filter press. This is commonly used in agriculture (Dijkstra et al. 2012) to help neutralize the soil pH at 7,5, by acting as a buffer on acid soils.

As a fertiliser, it improves the release of the intrinsic nutrients ( $\text{Ca}^{2+}$ ) due to increasing the pH value. It also improves the biological activity and soil structure. Calcium carbonate is almost water-insoluble and dissolves only in acid soils (up to a neutral pH range) and is plant available simultaneously. Surplus calcium carbonate is available in the next year for prevention of soil acidification during the fertilization season. Therefore, fertilization with calcium carbonate has a long-term depot effect.

Table 2-21  $\text{Ca}(\text{CO}_3)$  recovered from digestate from BENAS

	<b>Recovered <math>\text{CaCO}_3</math></b>
<b>DM (%)</b>	70-78
<b>CaO (kg/ton)</b>	280-370
<b>NH<sub>4</sub>-N (kg/ton)</b>	15-20
<b>S (kg/ton)</b>	18-22

A final product resulting from the FiberPlus® system are **digestate fibres**. The anaerobic digestion process does not break down lignocellulose. These fibres can be extracted and refined and are applicable in fibre industries (e.g. wood, paper) only when they contain low concentrations of ammonia. The SYSTEMIC demo plant in Germany has successfully isolated fibres from digestate with their FiberPlus system and tested the extracted fibres in different concentrations as resource in the fibre board industry (3% bio-fibres and 10-30% bio-fibres used) and paper industry (>80% biofibres used).

Table 2-22. Composition of Mageverde® biogas fibres produced in by BENAS

	<b>Magaverde®Biogas fibres</b>
<b>DM (%)</b>	50-90
<b>OM (% of DM)</b>	86-90
<b>NH<sub>4</sub>-N (kg/ton)</b>	0,02-0,6
<b>pH</b>	5-7

### 2.2.2.3 Energy requirements

The inline  $\text{NH}_3$  stripper at the Aqua & Sole AD plant (2018) consumed 4.4 kWh/m<sup>3</sup> digestate treated (20,160 tons on 84 days)(Brienza et al. 2019).

Based on monitoring in 2018-2019, the stripper energy consumption was estimated at respectively 4.7 and 3.3 kWh/m<sup>3</sup> digestate treated.

Other values are found in the database, describing NH<sub>3</sub> stripping-scrubbing units with an assumed treatment capacity up to 800 ton/day having an average electrical energy consumption  $\pm$ Stdev.P of 6.5 $\pm$ 4.7 kWh/m<sup>3</sup> digestate (n=8).

The energy consumption for the stripping column only is reported as 14 kWh/kg of stripped nitrogen (Agro Business Park 2011). In the case of steam stripping, the electricity consumption is 0.45 kWh/m<sup>3</sup> liquid, while the consumption for thermal energy is equivalent to the production of 100 kg of steam per m<sup>3</sup>.

(FH Münster and Kalk 2021) in the L'AmmoRE project, treated 1m<sup>3</sup> of liquid fraction of digestate per h, used 12 kWhel/m<sup>3</sup> and 25-27kWhth/m<sup>3</sup>. The power requirement of an industrial scale system would be around 5kWh/m<sup>3</sup> because residual heat from the CHP could be used.

Average thermal energy consumption  $\pm$ Stdev.P, assumed for treating up to 800 ton/day is calculated as 79 $\pm$ 14.2 kWh th/m<sup>3</sup> digestate (n=4).

Due to the lack of data and details in the data, the accurateness of these values is uncertain.

For the FiberPlus system of GNS installed at Demo Plant Benas, the energy consumption is estimated at 7kWh/ton and 80-96kWh th/ton, when stripping-scrubbing raw digestate. If liquid fraction of digestate was treated, this was estimated to reduce to 4.8 kWh/ton and 75-92 kWh th/ton.

#### **2.2.2.4 Storage capacity**

An ammonia stripper-scrubber can vary in surface and height. The surface needed is estimated at 50-100m<sup>2</sup> and height of 10-20 meters. Storage capacity for the produced end products can be calculated based on the treated volumes and mass recovery rate.

#### **2.2.2.5 Costs**

**The capital expenditures (CAPEX)** are the investment costs. Table 2-23 gives some values for CAPEX of a NH<sub>3</sub> stripping-scrubbing unit in relation to the treatment capacity.

Table 2-23 CAPEX vs treatment capacity of a NH<sub>3</sub> stripping-scrubbing unit (SYSTEMIC database, December 2020). 8000 hours per year

Treatment capacity (ton/h)	CAPEX (€) Average ±Stdev.P	n	Additional information
pH increase with CO <sub>2</sub> stripping			
1-4	550.000±150.000	4	
4-5	562.500±187.500	2	
10-15	450.000±50.000	2	Including tanks and condensers
15-20	746.625±78.375	2	
16	250.000	1	Only stripping column
37	9.250.000±150.000.000	2	90% recovery of NH <sub>4</sub> -N
(kg N/year scrubbed)	CAPEX (€)		
10.000	150.000		
28.361	400.000		
52.560	800.000		
534.725	1.500.000		
1.831.200	5.000.000		
Treatment capacity (ton/h)	CAPEX (€) Average ±Stdev.P	n	
pH increase with alkali addition			
37	1.040.000±540.000	2	90% recovery of NH <sub>4</sub> -N
Treatment capacity (ton/h)	CAPEX (€)	n	
FiberPlus® GNS (NH <sub>3</sub> stripping-scrubbing with gypsum)			
2.5	1,000,000		80% NH <sub>4</sub> recovery on digestate including filter press
5	1,400,000		(vessels and pumps are most expensive)
10	1,700,000		
15	2,000,000		
2.5	850,000		80% NH <sub>4</sub> on LF of digestate including filter press
5	1,150,000		(vessels and pumps are most expensive)
10	1,400,000		
15	1,600,000		

The large variances can be attributed to the fact that some CAPEX data contain also the costs for installation of the technology and programming of the Programmable Logic Controller (PLC). These extra costs are not always specified, so a 'clean' figure for the cost of only a centrifuge was not possible to obtain.

Data from the SYSTEMIC database, based on a.o. (Vaneekhaute 2015) and personal communication with technology suppliers like Colsen, GNS and Nijhuis Industries.

Capital costs of stripping depend on the method used for pH-increment. Other significant influences on the investment price are the scale of the installation and the availability of residual heat (Menkveld and Broeders 2017). If not enough heat is available, this can be compensated by a better heat recovery which will increase the investment costs.

**The operational expenditures** (OPEX, here considered as the pure processing cost, can include various costs like equipment maintenance costs, costs of chemicals and additives and labour costs.

If OPEX data was found, it generally an estimation on a yearly base, which was often reported as a percentage of the CAPEX (Table 2-24).

The large variation can be attributed to the fact that it was also not always clear which cost items were included in this percentage.

Operational costs depends on many different factors like: operational temperature, pH, and liquid flow rate.

### ***Cost of chemicals***

Alkali addition is normally adopted in practical plants due its low cost. However, high dosage of lime is needed, which leads to an unexpected high cost. For instance, (Liu et al. 2015) have used at lab scale up to 7.4 g of lime/L pig manure digestate to reach pH 12.5. This would lead a dosage of 4.44-11.47€/h at a scale of 5 m<sup>3</sup>/h (assumption 0.12-0.31€/kg Ca(OH)<sub>2</sub>).

The project L'AmmoRE uses at 60-65L milk of lime (20%)/m<sup>3</sup> of LF of digestate to increase the pH to 10.5 and recover 96% of the ammonia as an ammonia solution (FH Münster and Kalk 2021).

(Vaneekhaute et al. 2017) estimated the use of H<sub>2</sub>SO<sub>4</sub> for scrubbing of stripping gas from digestate at 1.5 L H<sub>2</sub>SO<sub>4</sub>/kg NH<sub>3</sub>, rendering a cost of 0.23€/kgNH<sub>3</sub>(assumption 0.086€/kg H<sub>2</sub>SO<sub>4</sub> 96%, 1.84kg/L).

FiberPlus system at Benas consumes around 8.6-70 kg FGD gypsum/ton digestate (2-16 ton/day), contributing to a cost of 0.10-0.84 €/m<sup>3</sup> digestate (input NH<sub>4</sub>-N 4g/kg, 80% N recovery efficiency, 12 €/ton gypsum).

This of course varies widely with the amount of scrubbing agent to achieve a predetermined removal efficiency.

Table 2-24 Data on the OPEX of the centrifuge from the SYSTEMIC database, December 2020.

Source	OPEX	Remarks
(Barampouti et al. 2020)	2 to 7€/kg N	Cost breakdown not specified
(Herbes et al. 2020)	1.95€/m <sup>3</sup> digestate	Operation and labour 2000kWh H+; R-scenario
(Vaneekhaute 2015)	8.6€/m <sup>3</sup> digestate	90% recovery of NH <sub>4</sub> -N, pH increase with CO <sub>2</sub> stripping
(Vaneekhaute 2015)	4.5€/m <sup>3</sup> digestate	90% recovery of NH <sub>4</sub> , pH increase with NaOH addition
(Collivignarelli et al. 1998)	8.1€/m <sup>3</sup> digestate	90 % NH <sub>3</sub> recovery efficiency, 70 °C, a pH of 11 and flow rate of 70 m <sup>3</sup> /h
(Collivignarelli et al. 1998)	2 €/m <sup>3</sup> digestate	90 % NH <sub>3</sub> recovery efficiency, 30 °C, a pH of 11 and flow rate of 70 m <sup>3</sup> /h
(Bolzonella et al. 2017)	5.44€/m <sup>3</sup> 4% of CAPEX	Heat: 0V/kWh Electricity: 0.1 V/kWh
Personal communication technology provider, 2020	0.4€/ton 3.67€/ton 0.15 €/ton	NH <sub>3</sub> stripping 183.000 ton/year; 6250h Electricity (0.08€/kWh) Heat (steam, 0.035€/kWh) Maintenance
GNS, 2020	(% of the CAPEX) 4.2 3.7 3.5 3.4	FiberPlus on digestate including filter press 2.5 ton/h 5 ton/h 10 ton/h 15ton/h
GNS, 2020	(% of the CAPEX) 4.5 3.9 3.7 3.6	FiberPlus on LF of digestate including filter press 2.5 ton/h 5 ton/h 10 ton/h 15ton/h



## 2.2.3 Membrane technologies

### 2.2.3.1 Technology description

Membrane technology is mostly used on a pre-treated (liquid fraction of) digestate stream, meaning that most of the solids have been removed.

The input stream is forced through the membrane's pores by means of pressure. The pore size of the membrane determines which molecules go through and the pressure to be used (Table 2-25).

Micro filtration (MF) and/or ultra-filtration (UF) separate all remaining suspended solids and colloidal dispersed fraction (MF), macromolecules (UF) into a "concentrate".

Waeger et al. (2010) recommended ceramic ultrafiltration membranes with pore sizes of 20–50 nm for biogas digestate filtration applications.

The water with dissolved compounds like ammonium is not retained by these membranes and this stream is called the "permeate".

In order to further purify the permeate, nanofiltration and reverse osmosis (RO) can be applied.

Unlike RO membranes, which reject almost all solutes (low molecular, neutral molecules like CO<sub>2</sub> and NH<sub>3</sub> will pass), NF membranes will reject most multi-valent ions but a significant amount of mono-valent ions will pass.

RO can also be used on a pre-processed digestate stream, such as the condensate of the evaporator, liquid fraction from DAF, pre-treated with a paper filter. When using RO as a final separation step, also nutrients (i.e. ions) can be separated in the concentrate stream, however the concentrations are not as high as in synthetic mineral fertilisers.

The permeate stream generated from RO contains low concentrations of nutrients and can be discharged to sewer or surface water, if necessary after a 'polishing' step, or re-used as process water (Hoeksma and De Buissonjé 2011; Hoeksma, de Buissonjé, and Aarnink 2012). Therefore, membrane techniques are often used to reduce the volume of the digestate stream (Lebuf et al. 2013).

Table 2-25 Characteristics of different membrane filtration types. Source: Lenntech.com. TM= transmembrane

Type of membrane	Pore size <sup>3</sup>	TM pressure	Membrane material	retains
<b>Microfiltration</b>	0.1-1µm	1-3 bar	Organic materials, e.g. polymer based membranes Inorganic materials, e.g. ceramic or stainless steel	Suspended particles, bacteria
<b>Ultra-filtration</b>	200nm-10nm	2-10 bar	Polymer materials, e.g. polysulfone, polyethersulfone, polyvinylidene fluoride, polypropylene, cellulose acetate, polylactic acid Ceramic membranes for high temperature applications.	+ viruses
<b>Nano filtration</b>	10nm-1nm	8-40 bar	Organic, thin-film composite membranes	+some multi-valent ions
<b>Reverse osmosis</b>	<1nm	10-100 bar	Semi-permeable, thin film composite membranes: -Polyester support web -Microporous polysulfone interlayer - Ultra thin polyamide barrier layer	+multivalent ions +monovalent Ions

### Testing and selection of membranes

When considering to implement membrane filtration technology in the current digestate treatment, first some pilot tests can be done by the technology supplier to estimate the performance, type of membranes used, cleaning strategy and intervals, etc. This is because every type of digestate can have different settings and constraints to maximize the performance of the membrane filtration. It is important to test long enough (cfr. Several months), so also fouling issues become visible and quantifiable (personal communication SYSTEMIC biogas plants, 2020).

<sup>3</sup> NF and RO membranes technically don't have pores, their separation ability is not based on particle size but on differences in diffusion velocity of ions and particles. The pore size indicated here gives an indication on the size of the particles that can be retained by these membranes.

## **Fouling and Scaling**

The biggest problem in membrane filtration is clogging and fouling of the membrane, which increases the hydraulic resistance and therefore the energy consumption. Consequently, the output flows will be reduced. This eventually decreases the performance of the membrane. Blocking of the pores is related with the particle size distribution in the digestate (Waeger, Delhaye, and Fuchs 2010) but the fouling rate also depends on different types of particles and substances:

In the case of **fouling**, suspended solids (i.e. colloids of  $1\mu\text{m}$ - $1\text{nm}$ ) can stick to the surface of the membranes. Because of the construction of spiral wound RO membranes, they require an input stream that is almost completely clear of any suspended solids. This illustrates the importance of the pre-treatment of RO to be able to remain continuous operation (Keysers 2006, personal communication SYSTEMIC biogas plants, 2020).

Fouling can also be caused by organic substances like humic acids, oil, hydrocarbons and (bio)polymers, extracellular substances (EPS), or soluble microbial products (SMP) that adhere to the membranes. This can also include components in additives used in previous process steps (for example, silicones in the anti-foam, polymer solution). This stresses the importance of pilot testing for longer periods (personal communication SYSTEMIC biogas plants, 2020).

**Scaling** is the process where inorganic substances reach the saturation level in the solution and precipitate as salts that separate from the liquid and stick to the membrane. This will create a starting point for further salt crystal formation and will cause gradual blocking of the membranes. This will eventually be visible as an increasing transmembrane pressure, pressure drop along the membrane and a decreased salt retention (Keysers 2006, personal communication SYSTEMIC biogas plants, 2020).

**Bio-fouling** indicates the process of single-celled organisms such as bacteria or fungi colonizing the membranes.

## Mitigation of fouling and scaling

Dead-end UF can only be applied if the amount of suspended solids in the input flow is <math><500\text{mg/L}</math> (Figure 2-15). This is frequently not the case when treating digestate, therefore cross flow filtration is used. This mitigates the fouling by using increased tangential velocities on the cross-flow. Fouling can also be reduced by ultrasonication or intermittent backwashing by air or permeate water (UF).

In case physical methods are insufficient, chemical means such as acidic or alkaline media, surfactants, chelants, oxidants, should be used to recover the capacity of the membranes (Shi et al. 2018).

Cleaning with a negatively charged dispersant can be used to adhere to the colloids and lift it from the membrane surface.

In cases where the membranes do not tolerate a high pH, enzymes such as protease and amylase are used as catalysts for the hydrolysis of the organic compounds blocking the pores. (Keysers 2006)

However, when RO membranes are clogged, frequently the only option is to replace them.

Scaling can be prevented by inducing extreme pH values (usually caustic) and using anti-scalants (i.e. chelating agents). High or low pH can often dissolve the crystals, but in many cases chelating agents are needed to alter and dissolve the apparent solution of the foulants, preventing them to form precipitable salts.

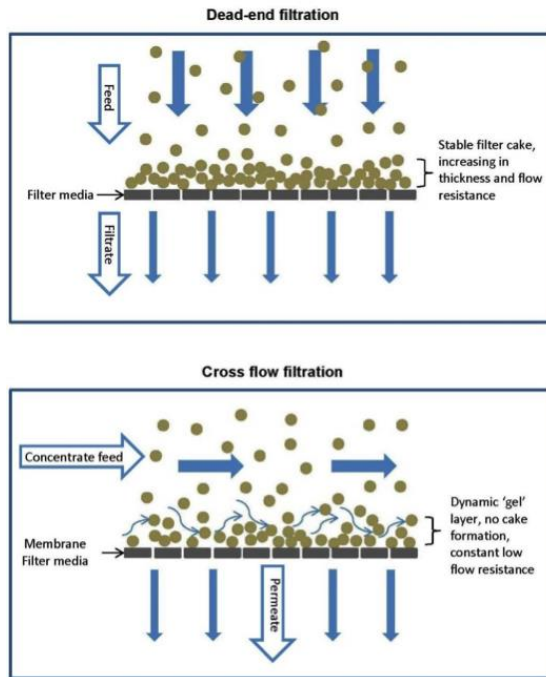

Figure 2-15 Scheme of Dead-end and cross flow filtration. Source:

<http://www.porexfiltration.com/learning-center/technology/what-is-cross-flow-filtration/>

Bio-fouling cannot be removed easily (Zhang and Farahbakhsh 2007)

The frequency of membrane replacement and the amount of cleaning products necessary depends on the input stream flow and characteristics, and the efficiency of the pre-treatment steps.

In general, the membranes should be cleaned when the flow decreases or when the differential pressure across the membrane ( $\Delta p$ ) increases. Many membrane system operators and technology suppliers follow the 10 percent rule; i.e. if the flow drops by 10% or the  $\Delta p$  increases by 10%, the system should be cleaned. Likewise, if the pressure supplied to feed to produce a certain amount of permeate rises by 10%, a cleaning must be initiated (Keysers 2006). This rule works for drinking water production and distillate filtration. In case of digestate treatment much higher fouling levels are accepted. In case a DAF and filterpaper is used as pre-treatment, frequently cleaning intervals of 8-24h are applied. But in other situations weekly or even monthly cleaning is enough. The cleaning regime needs to be optimized for each case (personal communication technology provider, 2020).

The key is to find a balance in optimizing the performance of a specific membrane configuration and digestate composition, while minimizing administration of cleaning agents (caustic) and anti-scalant.

By closely monitoring the DM level of the input stream, the design software of the suppliers can predict relatively accurate the performance and the cleaning intervals needed (personal communication technology provider, 2020).

### **2.2.3.2 Separation efficiency**

Ranges of recovery rates for MF, UF and RO are shown in Table 2-26, Table 2-27 and Table 2-28. The recovery rates for UF coming from the database are characterized by a large variability, probably due to the different types of input streams, pre-treatment efficiencies and operational conditions. Those for the RO step show high values, because the input of the RO is generally very "clean" by extensive pre-treatment steps.

While membrane processes are capable of producing relative clean permeate, it must not be overlooked that considerable quantities of sidestreams (i.e. concentrates) are generated. Only up to 50% of the treated whole digestate is recovered as purified water (Fuchs and Drosig 2013). At AM-Power this is 35% and for the GENIUS membrane filtration cascade at Groot Zevert only 13% (Brienza et al. 2020).

Table 2-26 Separation efficiency of the different steps in the GENIUS process at Groot Zevert Vergisting.

DMsus = suspended dry matter, DMsol = soluble dry matter, OM = organic matter, Total N = total nitrogen, NH<sub>4</sub>-N = ammonium nitrogen, Total P = total phosphorus, , Total K = total potassium, LF=liquid fraction, C=concentrate, MF=microfiltration, RO=reverse osmosis

		LF DAF	Separation efficiency C %	Permeate MF	Separation efficiency C %	concentrate	permeate	
		Input	MF	End product Input	RO	End product	End product	
<b>1</b>	<b>Mass</b>	Ton day <sup>-1</sup>	243	30	167	35	60	107
	<b>DM</b>	g kg <sup>-1</sup>					48.3	
	<b>OM</b>	g kg <sup>-1</sup>						
	<b>Total N</b>	g kg <sup>-1</sup>	5.3	59	3.0	98	8.1	0.1
	<b>NH<sub>4</sub>-N</b>	g kg <sup>-1</sup>	3.7	42	2.9	98	7.9	0.1
	<b>Total P</b>	g kg <sup>-1</sup>	0.6	96	0.03	100	0.1	0
	<b>Total K</b>	g kg <sup>-1</sup>	3.7	41	2.8	99	8.1	
	<b>Total S</b>	g kg <sup>-1</sup>	0.5		1.2		5.4	0
<b>2</b>	<b>Mass</b>	Ton day <sup>-1</sup>	161	41	95	48	45	50
	<b>DM</b>	g kg <sup>-1</sup>		67		100	43	-
	<b>OM</b>	g kg <sup>-1</sup>		83		100	17.3	-
	<b>Total N</b>	g kg <sup>-1</sup>	4.7	55	3.5	99	7.5	0.0003
	<b>NH<sub>4</sub>-N</b>	g kg <sup>-1</sup>		41		100	7.0	0.0002
	<b>Total P</b>	g kg <sup>-1</sup>	0.2	81	0.08	100	0.2	<0.0001
	<b>Total K</b>	g kg <sup>-1</sup>	4.2	41	3.9	100	8.3	<0.0004
	<b>Total S</b>	g kg <sup>-1</sup>		64				

<sup>1</sup> GZV 112kt feedstock per year: 67% pig slurry, 4.5% cattle slurry, 9% slaughterhouse manure, 16% Co-product dairy industry, 3.5% glycerine (Brienza et al. 2019) micro filtration and reverse osmosis: April 24th and May 7th 2019 average of samples taken (n=2)

<sup>2</sup> GZV 112kt per year: 67% pig slurry, 4.5% cattle slurry, 9% slaughterhouse manure, 16% Co-product dairy industry, 3.5% glycerine (Brienza et al. 2020) (T07 - T10): 22-10-2019 - 29-1-2020; average (n=4)

Table 2-27 Separation efficiency at AM-Power's RO.

DM = dry matter, OM = organic matter, Total N = total nitrogen,, Total P = total phosphorus, Total K = total potassium, C=concentrate

<sup>1</sup>		Condensate evaporator	Separation efficiency C %	concentrate	permeate
		Input	RO	End product	End product
<b>Mass</b>	Ton day <sup>-1</sup>	71	27	13	36
<b>DM</b>	g kg <sup>-1</sup>			17 ± 1.5	
<b>Total N</b>	g kg <sup>-1</sup>	1.3 ± 0.05	83	3.9 ± 0.005	0.15 ± 0.005
<b>Total P</b>	g kg <sup>-1</sup>	0.0059 ± 0.0002	99	0.024 ± 0.01	0.000012 ± 0.0000073
<b>Total K</b>	g kg <sup>-1</sup>	0.053 ± 0.0020	99	0.21 ± 0.12	0.00025 ± 0.00013
<b>Total S</b>	g kg <sup>-1</sup>	0.91 ± 0.005	99	3.6 ± 0.065	0.0013 ± 0.0001

<sup>1</sup> AM-Power:161.3kt feedstock /year: 10% pig manure, 80% food and food industry waste, 6% glycerine and fats, 0.1% corn, 4% other organic waste. (Brienza et al. 2020) average of samples taken in the period February 2020 (n=2; when standard deviation is included n=4).

Table 2-28 Summary of separation efficiencies of membrane filtration to concentrate of different parameters from Table 2-26 and Table 2-27 and the SYSTEMIC database.

DM = dry matter, OM = organic matter, Total N = total nitrogen, NH<sub>4</sub>-N = ammonium nitrogen, Total P = total phosphorus, Total K = total potassium, SE=separation efficiency, C= concentrate, MF=microfiltration, UF=ultrafiltration, NF=nanofiltration, RO= reverse osmosis,

		<sup>1</sup> SE MF to C %	<sup>2</sup> SE UF to C %	<sup>3</sup> SE NF to C%	<sup>1</sup> SE RO to C %	<sup>4</sup> SE RO to C %	<sup>1</sup> SE RO to C %
<b>Pre-treatment</b>		separation		sieve	separation+DAF/MF/UF		separation+evaporation
<b>Mass</b>	Ton day <sup>-1</sup>	30-41	27±8		27	38±11	27
<b>DM</b>	g kg <sup>-1</sup>	67	50±9			97±5	
<b>OM</b>	g kg <sup>-1</sup>	83				100	
<b>Total N</b>	g kg <sup>-1</sup>	55-59	29±13		83	77±35	83
<b>NH<sub>4</sub>-N</b>	g kg <sup>-1</sup>	41-42	22±2	5-23		79±29	99
<b>Total P</b>	g kg <sup>-1</sup>	81-96	79±21	83-98	99	74±42	99
<b>Total K</b>	g kg <sup>-1</sup>	41	22±2	50-63	99	79±29	99
<b>Total S</b>	g kg <sup>-1</sup>	64			99		99

<sup>1</sup> Summary of the data in Table 2-26 and Table 2-27, minimum-maximum

<sup>2</sup> SYSTEMIC database (December 2020): filtered on Type of input: "digestate", end product: "concentrate", after: "separation+Ultrafiltration",  
Average SE ±Stdev.P; mass(n=5) , DM (n=4), Total N (n=4),NH4-N(n=2), Total P(n=4),  
Total K (n=2)

<sup>3</sup>(Gerardo et al. 2015)Lab scale, cattle slurry digestate separated with sieve 500µm mesh

<sup>4</sup> SYSTEMIC database (December 2020): filtered on Type of input: "digestate", end product: "concentrate", after: "separation+...+Reverse osmosis",  
Average SE ±Stdev.P; mass(n=17) , DM (n=5),OM (n=1) Total N (n=10),NH4-N(n=6),  
Total P(n=8), Total K (n=6)

### **The use of additives**

RO can remove  $\text{NH}_4^+$  for 90-95% but  $\text{NH}_3$  (gas) and  $\text{CO}_2$  behave like water and go through the membranes and end up in the permeate (personal communication technology provider, 2020). Therefore, the stream is usually acidified ( $\text{H}_2\text{SO}_4$ ), prior to the RO, to improve the retention of ammonia (pH 6.6–6.8). The acidification creates a shift in the ammonia equilibrium towards  $\text{NH}_4^+$  present (see 2.2.2.1), which can then be retained by the membranes as  $\text{NH}_4^+$  or ammonium sulphate. (Bilstad et al. 1992) reported a TAN removal of 75–96% at pH 8, while at pH 4 almost 100% efficiency was obtained.

### **Combination with other techniques** (e.g. pre-treatment)

Pre-treatment by MF,UF or DAF is generally the first step to protect the NF and RO membranes from fouling, but also influences the composition of the concentrate. For example, installations using a combination of a centrifuge and ultra-filtration or belt press and DAF have higher nutrient contents in their concentrate than the ones using a screw press and flotation (Velthof 2011).

Operating temperatures range from 10-40 °C. Increasing temperatures (20°C and 40°C) can lead to reduced viscosities of anaerobic sludges (Tobias Gienau, Kraume, and Rosenberger 2018) which can have a positive effect on the performance of UF. Also lower pressures are required. However, from an engineering point of view it will become more complex to design the whole system with heating. This could end up being a higher cost than the benefits you would have with the lower viscosity. Also, sudden changes in temperature can seriously damage the membranes, heating over far above 40°C is not advisable (personal communication technology provider, 2020).



## Composition of the end products

### *Permeate RO*

The permeate from the RO is very low in nutrients, ammonia and volatile compounds and can be used for dilution purposes or making polymer solution. Because of the low amount of ammonia still present, it cannot be used for example for cleaning of trucks (personal communication SYSTEMIC biogas plant, 2020). To further purify it up to discharge limits and eliminate smell, a second RO, activated carbon (AC), zeolites or ion exchange can be installed as a final polishing step to be able to discharge within governing surface water limits (personal communication SYSTEMIC biogas plants, 2020).

### *Concentrate RO*

At Groot Zevent Vergisting, the concentrate of the RO and ultrafiltration is mixed and used in the region as alternative for mineral fertiliser. They get paid for the amount of N on market level. However, they had to invest in machinery and transportation to apply it on the fields of the farmers. Because the concentration of nutrients is lower than conventional liquid mineral fertilisers, more has to be injected on the same surface but the injector has to be able to keep riding on the same speed than he does when injecting mineral fertiliser or manure. To further finetune the nutrient content of the concentrate towards specific crop demand, Groot Zevent also started blending other recovered products (ammonia water, ammonia sulphate solution) with the concentrate. In the end the concentrate ("Green Meadow Fertiliser") has a negative value for them, but the total balance ends up positive (personal communication SYSTEMIC biogas plants, 2020).

The composition of concentrates varies widely depending on the input, the type of membranes used, the process operation conditions (pressure, type of membranes, temperature) and the pre-treatment cascade e.g. (multiple) solid separation step(s), ultrafiltration/nanofiltration/vibrating membranes, etc. If for example is chosen to use less H<sub>2</sub>SO<sub>4</sub> before as conditioning for the RO, this will lower the sulphur content in the concentrate. However, also a less clean permeate will be obtained. More details on products can be found in the SYSTEMIC product fact sheets.

### **2.2.3.3 Energy requirements**

The electricity requirements of the GENIUS process (DAF + microfiltration + reverse osmosis) are expected to amount to 11.7 kWh of digestate. The most energy demanding unit step will be the micro-filtration step with 7 kWh of electricity consumed per m<sup>3</sup> of digestate (Brienza et al. 2018).

In the SYSTEMIC database, records for energy consumption for MF and UF are on average  $\pm$ Stdev  $8.5 \pm 8 \text{ kWh per m}^3 \text{ input}$  (n=9).

For nanofiltration this is estimated at  $1.1 \pm 0.4 \text{ kWh per m}^3 \text{ input}$  (n=2) and for RO-systems  $8.3 \pm 6 \text{ kWh per m}^3$  (n=15).

Due to the lack of data and details in the data, the accurateness of these values is uncertain.

#### 2.2.3.4 Storage capacity

The RO installation of AM-Power and Waterleau New Energy can treat up to  $10 \text{ m}^3$  per hour, and occupies a surface of 15-20  $\text{m}^2$ .

#### 2.2.3.5 Costs

**The capital expenditures (CAPEX)** are the investment costs.

*Table 2-29 CAPEX vs treatment capacity of a membrane filtration unit (SYSTEMIC database, December 2020)*

Treatment capacity (ton/h)	CAPEX (€)
<b>UF or MF</b>	
1	25.000
1	74.000
2	369700
10	260.000
<b>UF+RO</b>	
3	400.000
4	1.000.000
<b>MF+RO</b>	
1	120.000
<b>NF</b>	
1	30.000
<b>RO</b>	
2	15.000
2	20.000
2	84.300
10	120.000
10	145.000
10	200.000
10	300.000

The large variances can be attributed to the fact that some CAPEX data contain also the costs for installation of the technology and programming of the Programmable Logic Controller (PLC). These extra costs are not always specified, so a 'clean' figure for the cost of only a MF, UF or RO was not possible to obtain.

Data from the SYSTEMIC database were based on a.o. technology providers, (Bolzonella et al. 2017; Gerardo et al. 2015; Kuiper et al. 2006; R. W. Melse, Starmans D.A.J., and Verdoes 2002).

**The operational expenditures (OPEX, here considered as the pure processing cost,** can include various costs like equipment maintenance costs, costs of chemicals and additives and labour costs.

If OPEX data was found, it generally an estimation on a yearly base, which was often reported as a percentage of the CAPEX (Table 2-30).

For the GENIUS cascade at Groot Zeverd, the yearly maintenance costs of MF have been estimated at around 1% of investment. Yearly maintenance costs of RO & IX have been estimated at around 57,000 € + 1% of investment (Brienza et al. 2018)

*Table 2-30 Data on the OPEX of membrane filtration from the SYSTEMIC database, December 2020.*

Source	OPEX	Remarks
(Charlebois 2000)	4.22€/m <sup>3</sup>	Ultrafiltration + reverse osmosis
(de Hoop et al. 2011)	9-13€/m <sup>3</sup> 2% of CAPEX per year	Ultrafiltration + reverse osmosis
(Herbes et al. 2020)		Centrifuge + screw press +RO 2000kW H+ R-scenario
	2.78€/m <sup>3</sup>	Operation and labour
	3.31€/m <sup>3</sup>	Electricity
Technology provider, 2020	1.03€/ton	153.200 ton/year RO
(David Fanguero et al. 2017)	4-12€/m <sup>3</sup>	Centrifuge + ultrafiltration
(Buckwell et al. 2014)	6.05€/m <sup>3</sup>	Ultra-filtration
(Gerardo et al. 2015)	0.52€/m <sup>3</sup>	MF 1m <sup>3</sup> /h
(Gerardo et al. 2015)	1.12€/m <sup>3</sup>	NF 0.8m <sup>3</sup> /h

The large variation can be attributed to the fact that it was also not always clear which cost items were included in this percentage.

According to (Drosg et al. 2015; T Gienau et al. 2018a) the ultrafiltration step has the highest operational energy demand and consequently the highest operational costs.

The OPEX also depends on the level of automatization, which is eventually the choice of the plant owner. It is important to nuance that membrane filtration can be automated to operate several days or even a month on its own, but to a certain degree there is always monitoring by the operator needed for monitoring the general operation of the process, and looking at trendings, which can reveal underlying emerging problems.

### ***Cost of chemicals***

Average doses of acid for improving the  $\text{NH}_4\text{-N}$  separation efficiency of the RO are 3-13L  $\text{H}_2\text{SO}_4(96\%)$ /m<sup>3</sup> input (Kühne 2018, Waterleau New Energy, 2020). This would mean a cost of 0.5-2€/m<sup>3</sup> input (assumption 0.086 €/kg  $\text{H}_2\text{SO}_4$  96%, 1.84kg/L).

SAMCO (Samcotech.com) estimates the chemical costs as follows:

- Antiscalants: 0.011€ -0.033€/m<sup>3</sup> influent
- Filter cartridges: 0.011€- 0.033€/m<sup>3</sup> influent
- Membrane cleaning with a proper operating system:0.11€ -0.22€/m<sup>3</sup> influent
- Membrane cleaning with an improper operating system: as high as 0.88 €/m<sup>3</sup> influent

When membranes foul, the costs substantially increase, mainly because of the higher pressures needed and the cleaning or replacement of membranes. Operational cost could increase up to 50% to 100% and for a typical plant that runs a membrane filtration unit somewhere around 1-2€/m<sup>3</sup>, this could add another 2€/m<sup>3</sup>. So, if you're pumping 95,000m<sup>3</sup> a year, that equals an additional 190,000€ for operating with fouled membranes, which can also damage other equipment as a result.

## 2.2.4 Ion exchange

### 2.2.4.1 Technology description

Ion exchange is a water treatment process in which unwanted dissolved ions— like nitrate, fluoride, sulfate, and arsenic — are exchanged for other ions with a similar charge. The exchange process occurs between a solid (resin or a zeolite) and a liquid (for example RO permeate).

Resins are very small porous plastic beads (ca. 0.6 mm) which contain invisible water measured as “humidity” or “moisture content”. The structure of the resin is a polymer on which a fixed ion has been permanently attached. This ion cannot be removed or displaced; it is part of the structure. To preserve the electrical neutrality of the resin, each fixed ion must be neutralised with a counterion. This counterion is mobile and can get into and out of the resin bead.

In the process, the less desired ions in the solution are swapped for those that are considered more desirable. In case of cations (like  $\text{NH}_4^+$ ,  $\text{K}^+$ ) charged ions) this is usually sodium, which is the mobile counterion (a.k.a. active groups or functional groups) on the resin surface.

The anion resin bead has fixed quaternary ammonium cations ( $\text{CH}_2\text{—N}^+(\text{—CH}_3)_3$ ) with often chloride as a mobile counterion.

Resins including both cation and anion exchange ions are not possible, because the fixed cations inside the resin beads would neutralise the fixed anions and no exchange with the outside world would be possible. Therefore you need separate cation exchange resins and anion exchange resins (de Dardel 2021).

The number of functional groups in an ion exchange resin is its total capacity, which is usually expressed in equivalents per litre of resin. One equivalent is  $6.02 \times 10^3$  active groups.

A typical strong acid cation exchange resin has a total capacity of 1.8 to 2.2 eq/L. A typical weak acid cation exchange resin has a total capacity of 3.7 to 4.5 eq/L. A typical weak or strong base anion exchange resin has a total capacity of 1.1 to 1.4 eq/L (de Dardel 2021).

Resin materials have a finite exchange capacity. Each of the individual exchange sites will become full with prolonged use. When unable to exchange ions any longer, the resin must be recharged or regenerated to restore it to its initial condition. The substances used for this can include

sodium chloride, as well as hydrochloric acid, sulfuric acid, or sodium hydroxide.

Ion exchange resins are commonly used in columns. The solution to be treated flows through the resin. At the end some of the ions from the feed escape into the pure solution, and operation is stopped. a large industrial ion exchange column can contain 20,000L of resin, sometimes more (de Dardel 2021).

### **Fouling and Scaling**

The efficacy of ion exchange for water treatment can be limited by mineral scaling, surface clogging, and other issues that contribute to resin fouling. The efficiency of the pre-treatment process (e.g. membrane filtration) or addition of chemicals can help reduce or prevent these issues (Fluence 2021).

#### 2.2.4.2 Separation efficiency

The recovery rate to the spent regenerant solution is estimated between 80-99,9% ([www.uvm.baden-wuerttemberg.de/xfaweb](http://www.uvm.baden-wuerttemberg.de/xfaweb), de Dardel 2021).

Table 2-31 Separation efficiency of ion exchangers in the GENIUS process at Groot Zevert Vergisting.

TC= total carbon, IC=inorganic carbon, TOC=total organic carbon, Total N = total nitrogen, NH4-N = ammonium nitrogen, Total P = total phosphorus, Total K = total potassium, Total S=total sulphur, perm=permeate, IX=ion exchange, RO=reverse osmosis, cat= cationic, an= anionic, RR = recovery rate

		Perm RO2	RR to perm %	Perm after IX-cat and an
		Influent	IX-cat and IX-an	End product
Mass	Ton day <sup>-1</sup>	43	100	43
		46	100	46
		56	100	56
TC	g kg <sup>-1</sup>	0.178	0.8	0.0014
		0.0983	1.2	0.0012
		0.0563	1.6	0.0009
IC	g kg <sup>-1</sup>	0.0174	6.3	0.0011
		0.0961	0.9	0.0009
		0.0556	1.4	0.0008
TOC	g kg <sup>-1</sup>	0.004	7.5	0.0003
		0.0022	13.6	0.0003
		0.0579	0.1	0.00006
EC	µS/cm	586		3.9
		651		3.7
		483		3.2
Total N	g kg <sup>-1</sup>	0.0616	0.5	0.0003
		0.0761	0.4	0.0003
		0.0589	0.2	0.0001
NH <sub>4</sub> -N	g kg <sup>-1</sup>	0.0531	0.5	0.00024
		0.074	0.4	0.00029
		0.0479	0.1	0.00006
Total P	g kg <sup>-1</sup>	0.00001	0	0
		0.00002	0	0
		0	0	0
Total K	g kg <sup>-1</sup>	0.0114	0.2	0.00002
		0.01	0	0
		0.098	0	0
Total S	g kg <sup>-1</sup>	0.5	0.8	0.00421
		1.059	0	0.00051
		0.527	0	0.00003

GZV:

T15

T16

T17

sampling of "G16": perm RO2= RO2 permeate before degassing and IX. Average of (T15-T17) (n=3), density = 1kg/L

sampling of "G17": perm after IX-cat and IX-an= permeate after anionic ion exchanger and buffertank, ready for discharge to surface water

Average of (T15-T17) (n=3), density = 1kg/L

## **Composition of the end products**

### *Spent regenerate solution*

The primary substance remaining from the process is called "spent regenerant." It contains not only all of the ions removed, but also any extra regenerant ions, and will also have a high level of total dissolved solids. Regenerant can be treated in a municipal wastewater facility, but discharges may require monitoring (Fluence 2021).

#### 2.2.4.3 Energy requirements

The energy requirements are only needed for the pumps and therefore generally as low as 0.1kWh/m<sup>3</sup> (Lemmens *et al.*, 2020).



#### 2.2.4.4 Costs

**The capital expenditures (CAPEX)** are the investment costs.

*Table 2-32 CAPEX vs treatment capacity of an ion exchange unit (Samco 2021)*

<b>Treatment capacity (L/min)</b>	<b>CAPEX (€)</b>	<b>Remarks</b>
<b>76</b>	42,000	two vessels (cation/anion), all FRP and PVC
	84,000	pipng, using eductors instead of chemical feed pumps, with a simple control panel and minimal instruments
	10-15%	estimation engineering cost
	15-40%	turn-key, prepackaged system
	5-10%	shipping costs
<b>76</b>	168,000	two vessels (cation/anion), in rubber-lined
	250,000	steel vessels with stainless-steel piping, high-end valves, a PLC control panel with instrumentation, and chemical feed pumps
	10-15%	estimation engineering cost
	15-40%	turn-key, prepackaged system
	5-10%	shipping costs
<b>depending on the size</b>		Regeneration of resins on site:
	85,000€	chemical handling system with storage tanks,
	250,000€	metering pumps, and forwarding pumps

All in all, there are 3 main factors that drive fluctuation in the capital cost of an ion exchange treatment system:

The flow rates, the amount of ions, types of ions and total dissolved solids that need to be removed and the construction material (PVC pipes and FRP tanks vs. stainless-steel).

The cost of engineering for this type of project can typically run 10–15% of the cost of the entire project and is usually phased in over the course of the project, with most of your investment being allocated to the facility's general arrangement, mechanical, electrical, and civil design (Samco 2021).

As with the previous technologies, the level of automatization also influences the CAPEX.

**The operational expenditures (OPEX, here considered as the pure processing cost,** can include various costs like equipment maintenance costs, costs of chemicals and additives and labour costs.

The main factors determining the OPEX are the cost for regeneration and replacement of the resins, the disposal cost of the spent resin solution and the power to run the system.

A "normal" resin service life can be based on the number of times it's regenerated; the more it's regenerated, the less life the resins will have as they eventually wear out. There are also other factors that will lessen their service life: changes in temperature, shock from resin scouring, chemical oxidation, fouling, scaling, etc.

The frequency of all these things will determine how long the resin will last and how often you will need to purchase new resin to replenish the spent resin. Generally it can be estimated that resins should be replaced every 3-5 years.

Also, the spent regenerant solution has to be disposed by a chemical waste treatment facility. This cost mainly depends on the liquid content (higher liquid content includes higher costs, also for transportation), the resin composition and contamination. If it contains hazardous materials, such as heavy metals, then it will either need to be treated as a hazardous waste, or the toxic materials will need to be stripped out of the resin material prior to disposal.

For non-hazardous resins, the disposal costs can range from 42€ to 85€ a ton. For hazardous, on the other hand, can be over 840 € a ton (Samco 2021).

These costs will depend on the facility's location, how far it must be hauled, the location state requirements, etc. and is therefore not included in the NUTRICAS Tool.

If OPEX data was found, it generally an estimation on a yearly base, which was often reported as a percentage of the CAPEX (Table 2-30).

For the GENIUS cascade at Groot Zevert, the yearly maintenance costs of IX have been estimated at around 1% of investment (Brienza et al. 2018)

*Table 2-33 Data on the OPEX of membrane filtration from the SYSTEMIC database, December 2020. SAC = strong acid cationic resins, WAC= weak*

*acid cationic resins, SBA= strong base anionic resins, WBA= weak base anionic resins*

<b>Source</b>	<b>OPEX</b>	<b>Remarks</b>
(Samco 2021)	Replace every 3-5 years	Resin replacement:
	1.2€ - 6€/ L resin	SAC and WAC
	4€ - 6€/L resin	SBA and WBA
	1.2 - 3€/L resin	Resin regeneration off-site:
(Brienza et al. 2018)	1% of CAPEX	

## 2.2.5 Evaporation

### 2.2.5.1 Technology description

Evaporation is a technique that is applied to reduce the water content of liquid streams, concentrating the nutrients. In addition to the food industry sector, evaporators are installed at AD plants to evaporate (liquid fraction of) digestate.

The liquid is heated to vaporize the water, which will reduce the volume of the initial product, often up to 80% (personal communication SYSTEMIC biogas plants, 2020). Some other components in the liquid also have a tendency to “escape” the liquid based on their vapour pressure. When evaporating (liquid fraction of) digestate, this will mainly be volatile organics (e.g. volatile fatty acids, CO<sub>2</sub> from carbonates) and ammonia. Dissolved ammonium in the (liquid fraction of) digestate will transfer to the gas phase as ammonia (NH<sub>3</sub>), according to the same principle as explained in Chapter 2.2.2.1. Stripping CO<sub>2</sub> and ammonia from the liquid will increase the pH of the liquid.

After evaporation, the water vapour containing volatile components is recovered by cooling it down. The result is a condensate or distillate containing a solution of ammonia that is salt-free with pH of >9 (Figure 2-16, left).

To prevent volatilisation of ammonia during the evaporation step, the pH of the influent of the evaporator can be adjusted to <6,5 by adding acid. This approach will cause only the water (and some volatile components) to evaporate and create a more concentrated digestate which still includes the ammonia (Figure 2-16, right). However, acidification can cause foaming due to the release of carbon acid.

The produced concentrate remains fluid or slurry-like and contains all non-volatile components (e.g. organic matter, nutrients and salts).

Unlike ammonia stripping, the goal of evaporation is usually not to strip ammonium out but to reduce the volume of the digestate hereby concentrating the nutrients in it. Therefore, the evaporation process does not usually include a pH increase step by means of CO<sub>2</sub> stripping or alkali addition.

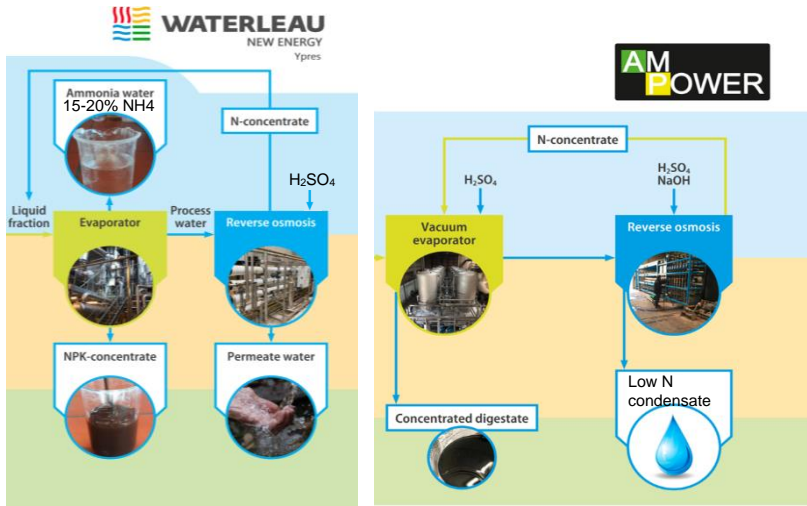

Figure 2-16 Evaporation cascade at Waterleau New Energy (left) without acidification, and AM-Power(right) with acidification.

## Configurations

Different configurations of the evaporator determine the amount of heat that can be re-used from the evaporation (Gruwez 2012).

Operating the evaporator at negative pressure (i.e. vacuum evaporation) will reduce the boiling temperature of the liquid. This way, low energy, recovered heat (e.g. from a CHP) can also be used to heat up the evaporator.

Single evaporators can reuse the energy by recompressing hot vapours from the condensation to warmer steam. Evaporators can also be put in series where the vapor generated in the first evaporator is used as heating steam for the next evaporator. In order to transfer energy from the steam to the liquid in each evaporator, the steam temperature has to be higher than the liquid temperature. Therefore, each consecutive evaporator is operated at a lower temperature than the preceding evaporator. Boiling can thus only be achieved in each evaporator by operating each at a slightly lower pressure than the preceding evaporator. As the boiling point for slurry increases with solid content, the liquid slurry should enter the last evaporator and run counter-current to the vapor (Hjorth *et al.*, 2010).

Next to the configuration for energy recovery, there are also different types of evaporators possible based on the mode of heat transfer and viscosity. For evaporation of (liquid fraction of) digestate mostly long vertical tube

evaporators with falling film, spray-film or forced circulation evaporators with external heat exchangers are used because they have proven to be more suitable for viscous and heat-sensitive liquids (Vondra, Máša, and Bobák 2017).

Falling film evaporators work best on flows with low to medium viscosity. Other systems, working with a heat exchanger in the boiling chamber are also applicable for evaporating digestate. (Automated) cleaning of the heat elements needs to be taken into account here.

### 2.2.5.2 Recovery efficiency

Most biogas plants have an excess of residual heat from the combined-heat-and-power (CHP) which can be used to raise the temperature to at least 80°C. When vacuum-evaporating at this temperature without adjusting the pH the recovery rate of ammoniacal-N could be theoretically 60 to 75% (Mykkänen and Paavola 2016). Evaporation can evaporate up to 80% of the water, creating a concentrate with 10-12%DM (max.30%)(Fuchs and Drosig 2013).

### Addition of chemicals

To prevent the volatilization of ammonia when evaporating digestate, it can be conditioned with acid. This will lower the pH, pushing the equilibrium of  $\text{NH}_4^+/\text{NH}_3$  to ammonium in solution. Normally the pH is only slightly decreased, towards 6-6,5. The amount of acid required to get to this pH, is again depended of the buffer capacity. Carbonate alkalinity is the major component of the buffer capacity. Other

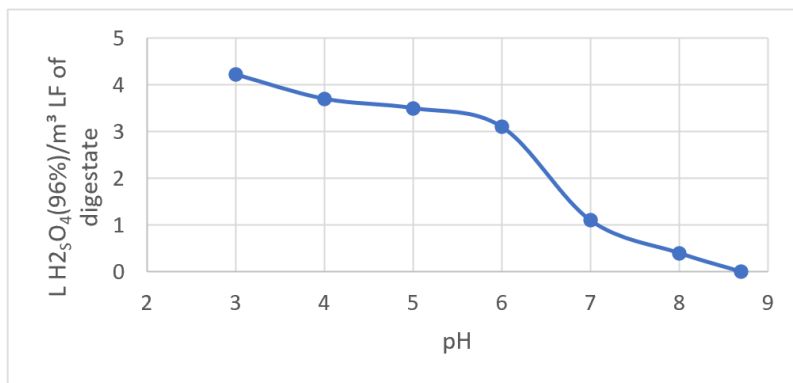

Figure 2-17 Titration curve for liquid fraction from digested pig slurry. LF= liquid fraction. Adapted from: (Bonmatí and Flotats 2012)

contributors to alkalinity are VFA, phosphates,  $\text{NH}_4\text{-N}$ , and some other components. The alkalinity of an anaerobic effluent is mainly caused by carbonates, as VFA has been consumed through the anaerobic digestion process. Because the pKa of bicarbonate is 6.24 a large amount of acid will be necessary to modify its pH to 6, but further decrease in pH can be achieved with smaller acid additions (Bonmatí and Flotats 2012).

Table 2-34 Analyses on liquid fraction of digestate(input evaporator) and output products of different parameters from monitoring campaigns during the SYSTEMIC project at Demo plants AM-Power and Waterleau New Energy.

DM = dry matter, OM = organic matter, Total N = total nitrogen, NH4-N = ammonium nitrogen, , Total P = total phosphorus, Total K = total potassium, Total S = total sulphur

		<sup>1.1</sup> LF digestate	Condensate	Concentrate	<sup>2</sup> LF of digestate	<sup>2</sup> Condensate	<sup>2</sup> Concentrate	<sup>2</sup> Process water
		acidification			No acidification			
Mass	Ton h <sup>-1</sup> Ton day <sup>-1</sup>	3.5-4.5 ±90	2.5-3 ±60	1-1.5 ±30	11-15 ±250	0.15-0.2 ±3.6	1-1.5 ±25	9-13 ±222
	pH	7.5±0.38	9.5±0.11	9.6±0.27	8.8	11	7.7	
	DM g kg <sup>-1</sup>	32.8±9.60	0.1 <sup>1.2</sup>	114±12	25±2.9		190±27	
	OM g kg <sup>-1</sup>	14.9±6.52	0.097	56.3±10.76	12±2.4		92±22	
	Total N g kg <sup>-1</sup>	2.6±1.44	1.3±0.16	4.3±0.71	4.5±0.45	86±27	11±5.0	1.5
	NH4-N g kg <sup>-1</sup>		1.2	3.4	3±0.74	86	2.7±3.6	
	<b>RR N*</b> %		<b>15-17</b>	<b>83-85</b>		<b>32</b>	<b>40</b>	<b>28</b>
	<b>RR NH4-N</b>		<b>14</b>	<b>86</b>		<b>48</b>	<b>14</b>	<b>38</b>
	TOC g kg <sup>-1</sup>		0.2±0.03	33±0.34	4.4±1.6	0.44±0.22	42±14	
	Total P g kg <sup>-1</sup>	0.3±0.15	0.002 <sup>1.2</sup>	1.8±0.34	0.28±0.083	0.00026±0.00056	12.1±0.75	0.0005
	Total K g kg <sup>-1</sup>	3.3±0.47	0.002 <sup>1.2</sup>	8.9±0.031	3.6±0.48	0.00011±0.000071	23±5.5	0.003
	Total S g kg <sup>-1</sup>	3.2±1.42	0.04 <sup>1.2</sup>	5.7±5.6	0.5±0.21	0.47±0.55	13±6.2	

<sup>1.1</sup>AM-Power:161.3kt feedstock /year: 10% pig manure, 80% food and food industry waste, 6% glycerine and fats, 0.1% corn, 4% other organic waste. average of samples taken in the period (October 2020- January 2021) (n=5) Average±Stdev. Acid addition and antifoam addition.

2 x 3 phase vacuum evaporator.

<sup>1.2</sup> AM-Power, Sampling on 3/2/2021 (n=1) Acid addition and antifoam addition

\*Depends on desired level of acidification. Assumed RR for NH4-N based on Total N concentration or NH4-concentration available.

<sup>2</sup> Waterleau New Energy, average of monitoring campaign (June- December 2020) (n=5),

600m<sup>3</sup> Falling film evaporator at atmospheric pressure, heating to 75°C with steam and heat recovery. Input:15m<sup>3</sup>/h  
assumption



Table 2-35 Summary of condensates and concentrates with and without prior acidification. Cond =condensate, Conc=concentrate

	<sup>1</sup> Cond	<sup>1</sup> Conc	<sup>3</sup> Cond	<sup>3</sup> Conc	<sup>2</sup> Cond	<sup>2</sup> Conc	<sup>3</sup> Cond	<sup>3</sup> Conc
	acidification				no acidification			
pH	9.5±0.11	9.6±0.27	5.3±1.5	6.0±0.2	11	7.7	7-9	7.3±1.6
DM g kg <sup>-1</sup>	0.1 <sup>1,2</sup>	114±12		233±44		190±27	0.07±0.05	143±27
OM g kg <sup>-1</sup>	0.097	56.3±10.76		103		92±22	0.05	100±18
Total N g kg <sup>-1</sup>	1.3±0.16	4.3±0.71	0.1	27.3±7.5	86±27	11±5.0	47.8±36.0	16.8±21.1
NH <sub>4</sub> -N g kg <sup>-1</sup>	1.2	3.4	0.17	18.9±0.9	86	2.7±3.6	38.8±41.5	2.9±2.2
<b>RR Total N</b>	<b>15-17</b>	<b>83-85</b>			<b>32</b>	<b>40</b>		
<b>RR NH<sub>4</sub>-N*</b>	<b>14</b>	<b>86</b>			<b>48</b>	<b>14</b>		
TOC g kg <sup>-1</sup>	0.2±0.03	33±0.34			0.44±0.22	42±14		
Total P g kg <sup>-1</sup>	0.002 <sup>1,2</sup>	1.8±0.34	0.05	6.0±2.5	0.00026±0.00056	12.1±0.75	0.003±0.006	1.5
Total K g kg <sup>-1</sup>	0.002 <sup>1,2</sup>	8.9±0.031		54.1±12.6	0.0001±0.00007	23±5.5	0	22.8±6.2
Total S g kg <sup>-1</sup>	0.04 <sup>1,2</sup>	5.7±5.6			0.47±0.55	13±6.2		

<sup>1,1</sup>AM-Power:161.3kt feedstock /year: 10% pig manure, 80% food and food industry waste, 6% glycerine and fats, 0.1% corn, 4% other organic waste. average of samples taken in the period (October 2020- January 2021) (n=5) Average±Stdev. Acid addition and antifoam addition.

2 x 3 phase vacuum evaporator.

<sup>1,2</sup> AM-Power, Sampling on 3/2/2021 (n=1) Acid addition and antifoam addition

\*Depends on desired level of acidification.

<sup>2</sup> Waterleau New Energy, average of monitoring campaign (June- December 2020) (n=5), preliminary results. Anti-foam addition.No acid addition. 600m<sup>3</sup> Falling film evaporator at atmospheric pressure, heating to 75°C with steam and heat recovery. Input:15m<sup>3</sup>/h, maximum 2% DM content

<sup>3</sup> SYSTEMIC database (December 2020):

filtered on Type of input: "digestate", chemical: "H2SO4", after: "separation-evaporation",. Average  $\pm$ Stdev.P;

end product: "concentrate", pH(n=8), DM(n=8),OM(n=1),N(n=8), NH4-N (n=4), P (n=8), K(n=7).

end product: "condensate", pH(n=4), N(n=3), NH4-N (n=1), P (n=1),

Concentration N in concentrate and condensate varies with the amount of acid added. Most input samples were acidified to pH 4-6 Filtered on Type of input: "digestate", end product: "condensate", chemical:

"none" or "anti-foam", after: "separation-evaporation",. Average  $\pm$ Stdev.P;

end product: "concentrate", pH(n=6), DM(n=9),OM(n=7),N(n=9), NH4-N (n=3), P (n=1), K(n=2).

end product: "condensate", pH(n=4), DM(n=14),OM(n=1),N(n=20), NH4-N (n=7), P (n=15), K(n=4).

AM-Power adds  $\pm$ 7-9 L H<sub>2</sub>SO<sub>4</sub> (96%)/m<sup>3</sup> liquid fraction to adjust the pH from 7.5 to 6. A lab scale study of Bonmati and Flotats (2012) only used 3 L H<sub>2</sub>SO<sub>4</sub> (96%)/m<sup>3</sup> liquid fraction to get from pH 8.7 to pH 6. These examples illustrate that buffer capacity varies depending on different types of digestates.

Foaming may also occur, especially at start-up with a more diluted digestates or CO<sub>2</sub> that is released when the digestate is acidified. Choice of anti-foaming agent and design of the acidification addition therefore of great importance.

Figure 2-18 shows the consumption of anti-foam in the evaporator at AM-Power. Waterleau New Energy uses 0.4L anti-foam/m<sup>3</sup> of liquid fraction and (Kühne 2018) also reported amounts of 0.3L/m<sup>3</sup> of liquid fraction in the evaporator. This shows that the amount of anti-foam used can vary. The efficiency of the anti-foam can be very specific for each type of digestate, and when selected and tested properly, can obtain lower consumption rates (personal communication AM-Power, 2021).

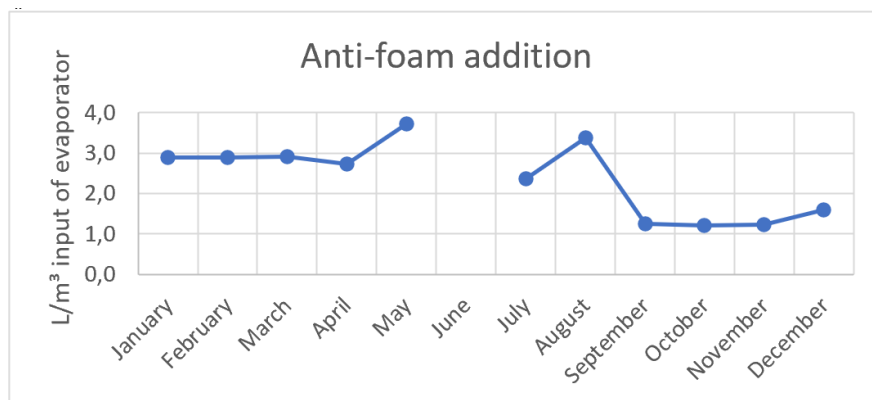

Figure 2-18 Anti-foam addition in the evaporator at AM-Power in 2020. After august there was a change in type of anti-foam, which appeared to be more efficient on the digestate.

### Combination with other technologies (pre-treatment and post-treatment)

Chiumenti et al. (2013) tested if the concentrate could be further thickened by evaporating it further in a second step (with acidification) (Chiumenti et al. 2013). To further increase the dry matter content, a drying step is needed (Lemmens et al., 2006).

The condensate can be further purified by means of reversed osmosis.

Evaporation of digestate causes gaseous emissions in the form of foul-smelling, non-condensable gases in the evaporator. A

method of air purification can therefore be necessary for exhaust gasses.

Changes in the composition of the digestate can cause problems in the evaporator, like changing levels of viscosity/adhesion, fouling and scaling of heat exchangers when in direct contact with the digestate, and corrosion of construction material.

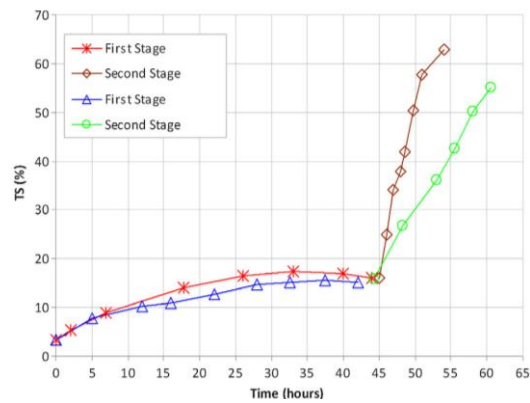

Figure 2-19 Typical evolution of total solids in concentrate, in first and second stages.

Source: (Chiumenti et al. 2013).

## Composition of the end products

Composition of the end products can be found in Table 2-35 and in the SYSTEMIC product fact sheets.

### 2.2.5.3 Energy requirements

Evaporation is a highly energy consuming process (up to 8-670 kWh/L water evaporated, depending on the type and energy recovery of the evaporator), because heat is needed to increase the temperature of the solution to vaporise water (EPCON, 2015).

(Chiumenti et al. 2013) estimated the energy consumption of a 2 step evaporation treating 50-100 ton of liquid fraction of digestate per day, at 5–8 kWh/m<sup>3</sup> of LF and 350 kWh/m<sup>3</sup> of evaporated water.

(Fuchs and Drosig 2013) also mention 300-350 kWh/m<sup>3</sup> of evaporated water.

One of the SYSTEMIC biogas plants has an evaporator (boiling chamber with coil heat exchanger) on liquid fraction, evaporating 40m<sup>3</sup> of water/h, which consumes approximately 1.62kWh/m<sup>3</sup> water evaporated (0.525 kWh/m<sup>3</sup> evaporator, 1.09kWh/m<sup>3</sup> for coolers). All thermal energy required is recovered heat from the CHP engines (personal communication with SYSTEMIC biogas plant, 2019).

EPCON has developed a mechanical vapour recompression (MVR) unit to heat up the steam for the evaporator, which would use 80-98% less energy than a conventional boiling process.

Integrating this in a falling film, single effect evaporator, treating 1000 – 200.000 kg/h would consume 10-25 kWh per ton water evaporated.

Integrated with a forced-circulation evaporator with the same capacity would consume 25-50 kWh per ton water evaporated. A combined system (falling film, forced-circulation, multiple effect) would consume 15-30 kWh per ton water evaporated.

This compared to a multiple effect evaporator with the same treatment capacity consumes per ton water evaporated 700-800kWh (single effect), 400kWh (2nd effect) and 200kWh (5th effect) (EPCON 2015).

For such amounts of energy is mostly feasible to re-use the heat from the CHP.

However, the consumption of energy depends on the configuration of the evaporator (multiple effect, pressure).

### 2.2.5.4 Storage capacity

The surface required for the evaporator depends on the type of evaporator. One single step (two boilers) takes around 25m<sup>2</sup>. At the AM-Power plant 2 three-phase evaporators occupy a surface of around 150m<sup>2</sup>, with a height of 3-4 meters. This can treat maximum 300 ton/day

The evaporator at Waterleau New Energy, processing 15m<sup>3</sup>/h has a volume of 600m<sup>3</sup> on a surface of 100-200m<sup>2</sup>, height 20 meters. Figure 2-20 shows these two types of evaporators. The evaporator at Atria (23ton/h) was estimated to occupy 104m<sup>2</sup> and have a height of 15m.



Figure 2-20 Evaporators in different configurations and sizes. Source: (Kühne 2018)(left), Waterleau New Energy

### 2.2.5.5 Costs

**The capital expenditures (CAPEX)** are very difficult to generalize because there are multiple factors that have an influence. The investment cost is partly determined by water evaporation capacity, type of evaporator, applied configuration (number of steps, vapour compression), construction material being used related to corrosion, temperature of available heat etc. Because of the many possibilities in different models and configurations only some examples are given of CAPEX in Table 2-36.

Table 2-36 CAPEX vs treatment capacity of evaporators (SYSTEMIC database, December 2020). Assumed 24 hours per day.

Max. treatment capacity (m <sup>3</sup> water evaporated/day)	CAPEX (€)	Additional information
1.5	50.000	No details given
7	155.000	No details given
30	300.000	No details given
40	490.000	No details given
	490.000	2018
	230.000	2015 Excl VAT and coolers
	350.000	2018 Single step evaporator + building Excl VAT and coolers
60	410.000	No details given
90	850.000	No details given
200	800.000	No details given
	1.000.000	No details given
250	1.500.000	2013 Falling film evaporator + stripper
	1.950.000	Evaporator 2x 3steps + heat exchangers
300	200.000	Installation and piping
	140.000	Condenser and cooling
360	2.500.000	No details given

**The operational expenditures (OPEX)**, here considered as the pure processing cost, can include various costs like equipment maintenance costs, costs of chemicals and additives and labour costs.

If OPEX data was found, it generally an estimation on a yearly base, which was often reported as a percentage of the CAPEX (Table 2-37).

The main operational cost for an evaporator is energy. This makes this technology attractive to biogas plants with combined heat-and-power (CHP) units that do not have any profitable use for their excess heat (Vondra et al., 2018). However, some technology provider supply evaporators that don't require heat (EPCON). In general, the maintenance costs are rather low.

Table 2-37 Data on the OPEX of the evaporators from the SYSTEMIC database, December 2020.

Source	OPEX	Remarks
(Gorissen and Snauwaert 2018)	2.5-50€/m <sup>3</sup> of condensate	Not specified
(Herbes et al. 2020)	2.19 €/m <sup>3</sup> digestate	500kW H+; R-scenario Operation and labour
	2.36 €/m <sup>3</sup> digestate	Electricity
(Herbes et al. 2020)	2.26 €/m <sup>3</sup> digestate	2000kWh H+; R-scenario Operation and labour
	1.14 €/m <sup>3</sup> digestate	Electricity
(Döhler and Wulf 2009)	10.06€/m <sup>3</sup> input	Not specified
Personal communication technology provider x, 2020		180.000 ton/year Electricity (0.08€/kWh)
	0.24€/ton	Evaporator
	0.16€/ton	Cooling tower
	0.10€/ton	Maintenance
Personal communication technology provider Y, 2020	20kWh/ton	23 ton/hour Electricity

### Cost of chemicals

Some examples are given for chemical cost, based on the amounts of chemicals stated in chapter 2.2.5.2.

A consumption of 3-10 L H<sub>2</sub>SO<sub>4</sub>(96%)/m<sup>3</sup> liquid fraction (pH adjustment to pH 6) would render a chemical cost of 17-60€/m<sup>3</sup> of liquid fraction (3€/kg H<sub>2</sub>SO<sub>4</sub> 96%, density 1.84kg/L).

Antifoaming agent may be required during start-up and in periods with unstable operation. Sometimes anti foaming agent can also be required during operation. This is depending on the properties of the actual digestate. The need, type and consumption of anti-foaming agents have to be verified during long term pilot tests. Based on anti-foam consumption of the demo plants, anti-foam consumption of 0.3-1.5L anti-foam/m<sup>3</sup> of liquid fraction would render a cost of 0.75-5.25 €/m<sup>3</sup> of liquid fraction (2.5-3.8 €/kg anti-foam).

## 2.2.6 Thermal drying

### 2.2.6.1 Technology description

The purpose of thermal drying is to reduce the volume and mass of the digestate. Evaporation and dewatering can maximally achieve an end product with dry matter content of 30-40%. When a drying step is added, the dry matter content can be increased to 95-95%.

Thermal drying relies on evaporating water by heating up the product by means of heat transfer from another medium (e.g. air, steam, heated oil). Preferably the heat is residual heat from the CHP.

During drying, a germ-count reduction also occurs. Every type of digestate has specific drying characteristics. Also air velocity, pressure and temperature will have an influence on the drying process (de Vogeleer 2009).

There are many drying digestate systems on biogas plants in Europe and the predominant systems used are: belt dryers, fluidized bed dryers and indirect dryers (Bamelis 2016; Buckwell et al. 2014; Drosig et al. 2015).

One type of classification can be made based on the contact between the heated medium and the product:

**Direct dryers** (a.k.a. convection dryers) directly use the evaporation energy of the heat medium, which can be heated air or even flue gasses. During and after drying, the heated air/gasses will contain many volatile components (like ammonia) and dust originating from the drying of the product.

**Indirect dryer** (a.k.a. conduction dryers) dry the product by transfer of heat through a surface (i.e. a heat exchanger), meaning that the heat medium does not come into direct contact with the product (Bamelis 2016). The heat medium can be a hot liquid (e.g. thermal oil, hot water) or gas (e.g. steam).

Depending on the chosen medium, there may or may not be a need for the extension of the contact surface. Each type of medium has its own advantages and disadvantages (personal communication Waterleau, 2016):

*Hot water* is often immediately available from cooling or production processes. Because of the lower temperature, a larger contact surface is required and a high flow. The heat exchange is about 20 ° C.

*Steam* ensures that a high temperature heat exchange is possible, limiting the required contact surface and flow. However, this medium places some restrictions on construction because of the higher pressures involved.

*Thermal oil* combines a high temperature and heat exchange at relatively low pressure. Like steam, a smaller contact is surface required, yet it requires a higher mass flow compared to steam.

The main advantages of working with an indirect dryer (such as the Hydrogone®) are that due to the lack of direct contact between hot gases and dry dust, a safer process is created. The dryer is airtight, so that work can be carried out below the explosion limit. In addition, the systems are characterized by a high evaporation rate (large contact surface) and a high efficiency (both thermal and electrical). Maintenance of this type of installations is also limited, because there are few moving parts. The investment cost is a disadvantage. Moreover, this type of dryer can only be used profitably from a certain scale size.

## Configurations

### Fluidized bed dryer

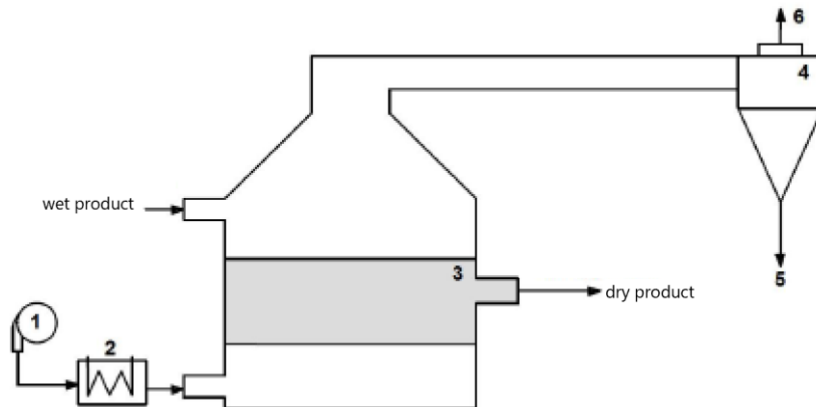

Figure 2-21 Scheme of a fluidized bed dryer. 1) fan 2) air heater, 3) drying chamber, 4) cyclone, 5) dust, 6) exhaust air. Source: (de Vogeleer 2009)

In a fluidized bed dryer, the product to be dried is placed on a perforated, gas distributor plate (the "bed") in a vertical cylinder shaped drying chamber, through which the heat medium (air or flue gasses) is sent (0.2-3 m/s) from below.

Pressure drop across the bed increases as the fluidizing gas velocity is increased. At a certain gas velocity, the bed is fluidized when the gas stream totally supports the weight of the whole bed. This increases the contact surface with the heat medium.

The temperature in the dryer can range from 100-800°C (Bamelis 2016; Ceulemans and Schietecatte 2013).

Advantage of this type of dryer include low residence time (a few minutes), high rate of moisture removal, high thermal efficiency (70-85%), easy material transport inside dryer and ease of control.

Limitations include high pressure drop, poor fluidization quality of some particulate products, nonuniform product quality for certain types of fluidized bed dryers, erosion of pipes and vessels, entrainment of fine particles, attrition or pulverization of particles, and agglomeration of fine particles (Law and Mujumdar 2015).

### Belt dryer/tunnel dryer

The belt dryer or tunnel dryer is a continuous dryer where the product is placed on a perforated band or grid, through which a fan blows hot air in counter current or vertically at air velocities of 0.3-2.5m/s. This dries the product in the tunnel. It is important that the product is spread evenly on the belt, to prevent uneven drying and fire hazard.



Figure 2-22 Belt dryer. Source: Spiessens.be

The residence time depends on the size of the particles, the air velocity and the temperature and moisture content of the heat medium. The higher residence times (10-60 minutes) the product quality can easily be finetuned (de Vogeleer 2009).



Advantages of the belt dryer are the possibility to also work on lower temperatures (30-400°C), meaning that other heat sources can also be used (radiation heat, heat from the cooling circuit of the heat exchanger, etc.)

Limitations are the lower thermal efficiency compared to the fluidized bed dryer (55-75%) and a higher air flow, because of lower temperatures.

#### Rotating disk dryer

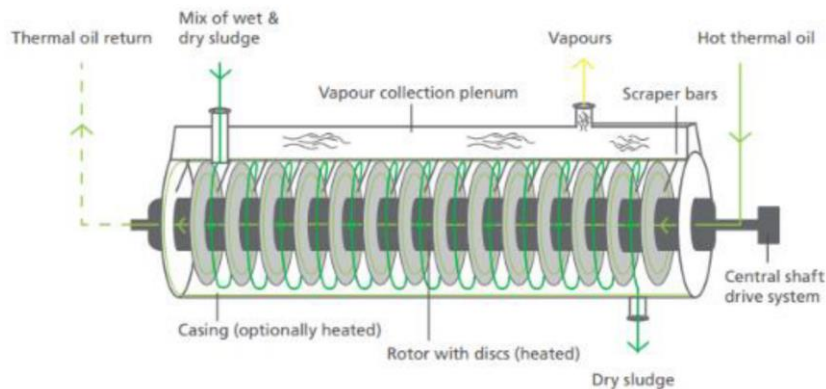

Figure 2-23 Scheme of a Hydrogone® rotating disk dryer from Waterleau Engineering.

The rotating disk dryer is a continuous dryer that consists of a rotor on which discs are attached. Both the rotor and the discs are heated by means of steam, hot water or thermal oil. The housing (jacket) around the rotor can also be heated (optionally). The product to be dried is mixed with dried product prior to entering the dryer to avoid sticking to the rotors. Once introduced, the product is slowly propelled through the dryer by the combined movement of the rotating discs, the "swords" on the discs and the partitions in the dryer, with optimum heat transfer (Bamelis 2016).

#### Solar drying

Solid fraction of digestate can be fed in a solar green-house dryer where it is mixed and aerated. The evaporation rate may range between 0.6 and 3.5 tons of water/y/m<sup>2</sup> (Barampouti et al. 2020).

#### 2.2.6.2 Recovery efficiency

Drying will reduce the amount of water with 80-90% creating an end product with a dry matter content between 65 – 98 % but on average at 85%DM (Bamelis 2016).

Next to the water, also gaseous components like ammonia will volatilize according to the temperature (see section 2.2.2.1). The dried end product is therefore free of odour and ammonia.

The drying process will not influence the amount of non-volatile components (e.g. phosphorus, potassium, other minerals and salts), which will remain in the dried product.

#### Combination with other technologies (pre-treatment and post-treatment)

With direct drying systems using air or exhaust gases as heating medium, an this exhaust air flow will contain also ammonia from the dried product, which will need to be treated in an air scrubber.

To prevent that particles stick together in a fluidized bed dryer, the moisture content of the incoming product has to be limited to max. 30 - 40 % (Bamelis 2016). For a belt dryer the particle size has to be larger than 5 mm.

Due to the combination of small particles, high organic matter content, high temperatures and low moisture content in the dried digestate, there is always a fire or explosion hazard. This is especially so for direct dryers that use hot air for drying. This risk is much lower in indirect dryers because of the different heat medium (Gorissen and Snauwaert 2018).

### Composition of the end products

Table 2-38 Analyses on dried digestate after drying in different types of dryers.

DM = dry matter, OM = organic matter, Total N = total nitrogen, NH4-N = ammonium nitrogen, Total P = total phosphorus, Total K = total potassium, Total S = total sulphur

	<sup>1</sup> Dried product	<sup>2</sup> Dried product	<sup>3</sup> Dried product	<sup>4</sup> Dried product
	Fluidized bed dryer		Belt dryer	Rotating disk dryer
pH	7.5		8	7.9
DM g kg <sup>-1</sup>	912	876±19	610±290	958
OM g kg <sup>-1</sup>	523			640
Total N g kg <sup>-1</sup>	31	23±3	18±3	31
NH4-N g kg <sup>-1</sup>	0.88			
Total P g kg <sup>-1</sup>	19	19±4	14±9	25
Total K g kg <sup>-1</sup>	11	14±2	19	15

<sup>1</sup>AM-Power:137.6kt feedstock /year: 9% pig manure, 81% food and food industry waste, 8% glycerine and fats, 0.1% corn, 2% other organic waste

(Brienza et al. 2019) average of samples taken in September-October 2018 (n=2). Fluidized bed dryer.

<sup>2</sup> SYSTEMIC database (December 2020): filtered on Type of input:"digestate", end product: "solid fraction", after:"drying-fluidized bed dryer"

Average SE ±Stdev.P; DM (n=3), Total N (n=6), Total P(n=6), Total K (n=2)

<sup>3</sup> SYSTEMIC database (December 2020): filtered on Type of input:"digestate", end product: "solid fraction", after:"drying-belt dryer"

Average SE ±Stdev.P; DM (n=4), Total N (n=3), Total P(n=3), Total K (n=1)

<sup>4</sup> Waterleau New Energy, average of sampling period June 2020-December 2020 (n=4)

### 2.2.6.3 Energy requirements

Table 2-39 shows some indicative values for energy requirements of different types of dryers.

Table 2-39 Energy requirements for dryers found in literature.

Source	Electricity	Heat	Type
(Barampouti et al. 2020).	310 kJ/kg water		
(Novem 1998)	100-200kJ/kg water	5050-7000 kJ/kg water	Fluidized bed
(Novem 1998)	200 kJ/kg water	4000 kJ/kg water	Belt dryer
(Huybrechts and Dijkmans 2001)	60 kWh/ton water	3250 kJ/kg water	Direct drying
(Novem 1998)	35 kJ/kg water	3850 kJ/kg water	Disk dryer (steam)
(Huybrechts and Dijkmans 2001)	25 kWh/ton water	2800-3300 kJ/kg water	Indirect drying
(Rehl and Müller 2011)	200 kWh/ton water		Solar drying Mixing and aeration

Due to the high energy requirements the business case around digestate drying only makes sense if there is access to sufficient renewable heat (EIP-AGRI Focus Group 2017).

#### 2.2.6.4 Storage capacity

Belt dryer take in a relatively large surface area (several hundred m<sup>2</sup> depending on the scale).

The fluidized bed dryer at the AM-Power plant occupies a surface of around 40m<sup>2</sup> (dryer 25m<sup>2</sup> + filterroom 10-12 m<sup>2</sup> or cyclones 8m<sup>2</sup>), with a height of 3-4 meters.

The rotating disk dryer at Waterleau New Energy requires a surface area of around 50m<sup>2</sup>, with a height of 3-5 meters.

#### 2.2.6.5 Costs

**The capital expenditures (CAPEX)** are very difficult to generalize because there are multiple factors that have an influence. The investment cost is partly determined by the drying capacity.

Because of the many possibilities in different models and configurations only some examples are given of CAPEX in Table 2-40.

Table 2-40 CAPEX vs treatment capacity of dryers (SYSTEMIC database, December 2020).

Treatment capacity (ton/h)	CAPEX (€) Most likely (Min-max)	Additional information
2	350.000 (250.000 - 700.000)	Fluidized bed dryer
5	(1.000.000 - 1.400.000)	
1.25	30.000	Belt dryer
3	150.000 (150.000 - 310.000)	
5	600.000 (500.000- 1.000.000)	

**The operational expenditures (OPEX)**, here considered as the pure processing cost, can include various costs like equipment maintenance costs, costs of chemicals and additives and labour costs. The OPEX is very difficult to estimate because there are multiple factors that determine costs such as: the type of dryer and the desired level of dry matter content etc. Table 2-41 shows indicative values for OPEX.

The main operational cost is energy.

Table 2-41 Data on the OPEX of dryers from the SYSTEMIC database, December 2020.

Source	OPEX	Remarks
(Bamelis 2016)	5-10 €/ton	Fluidized bed dryer, 2-5 ton/h
(Bamelis 2016)	4-8 €/ton	Belt dryer, 2-5 ton/h
(Bolzonella et al. 2017)	5,81 €/ton	Heat: 0 V/kWh Electricity: 0.1 V/kWh
(Nakazi et al. 2009)	7,4 €/ton	Heat: 0,03 V/kWh Electricity: 0.15 V/kWh Inc.storage

The maintenance costs in a fluidized bed dryer are low because there are no moving parts inside the dryer (Law and Mujumdar 2015). However, the treatment costs related to the air cleaning are higher than an indirect dryer (Bamelis 2016). This is also the case for a belt dryer. Here, there can be some maintenance on the belt when solid material sticks to it. This needs to be removed regularly otherwise the energy consumption will also increase (Bamelis 2016).

## 2.2.7 Biothermal drying/composting

### 2.2.7.1 Technology description

Biothermal drying (composting) is a natural process in which living organisms (bacteria, fungi, protozoa, etc.) convert fresh organic matter under controlled conditions and in the presence of oxygen into homogeneous, stable and humus-rich compost. The volume and mass are reduced by moisture evaporation, because the composting process is exothermic.



Figure 2-24 Biothermal drying. Source: VCM

Bacterial growth in the (solid) manure or digestate mixture increases the temperature and kills pathogens (at >

70 °C, for at least 1 hour; "hygenisation"). To achieve this, (poultry) manure, solid fraction of digestate or other biomass is often added (co-composting) to obtain an optimal C/N ratio (ideally between 25/1 – 35/1 at start-up) and thus achieve the necessary increase in temperature. Oxygen concentration can be maintained by regularly turning the compost (extensive composting) or by aeration (intensive composting). The ideal moisture content for a compost heap is 50-60% (Gorissen and Snauwaert 2018).

In addition, the organic material stabilizes. In a well-functioning process, the final product will comply with European Regulation Hygiene Standards (VO/1069/2009) and can therefore be exported. Coupling AD with composting may prove beneficial resulting in an integrated scheme. Shorter composting times along with high quality products are ensured (Manyi-Loh, C.E. Mamphweli and Meyer 2019).

It is a natural way for drying and can be regarded as nutrient recovery because all nutrients stay in the product, except for N, which might be lost in the form of ammonia (Magrí 2018). Any ammonia emission to the air should be avoided by implementing air washing systems, which allow for the recovery of 85% of the ammonia emissions in the form of ammonium sulphate solution (Hou 2016).

### Configurations

The process can place in tunnels that are aerated underneath. There are also composting drums available on the market, in which a rotating drum action ensures aeration (Gorissen and Snauwaert 2018).

### 2.2.7.2 Recovery efficiency

During a good operating composting process, the mass can be reduced with 10-25%, even as the dry matter content (Derden and Dijkmans 2020; R. Melse et al. 2004). 10 % of the organic matter is estimated to be mineralised during microbial activity in the composting process 20% of total nitrogen is estimated to be converted into N<sub>2</sub> gas (Derden and Dijkmans 2020).

When the composting process is managed badly, nitrogen losses are estimated to go up to 70% of total nitrogen (EC-JRC 2017). (Rehl and Müller 2011) estimated ammonia emissions up to 20% of total ammonia nitrogen. Theoretically there are no losses of P and K.

### **Addition of chemicals**

In order to ensure optimum C/N ratio and aeration conditions low C/N ratios can be boosted and high moisture can be reduced by enriching the composting mixture of solid fraction of digestate with suitable bulking materials (e.g. straw, wood chips, etc.) (Manyi-Loh, C.E. Mamphweli and Meyer 2019).

Depending on the wishes of the customer, potassium or lime can be added, by dosing e.g. Haspargit (from the production of citric acid) or precipitated calcium carbonate (from the sugar beet industry) (Camargo-Valero et al. 2015).

### **Combination with other technologies (pre-treatment and post-treatment)**

The solid fraction of the digestate after a separation is composted in many biogas plants to be exported abroad (Associated Plant IVVO, Belgium; Outreach Location GMB, The Netherlands).

### **Composition of the end products**

The composition of the end product depends on the incoming flows, which can be a mixture of solid fraction of pig or cattle slurry, cattle manure with straw, horse manure or poultry manure to obtain enough structure and an optimal C/N ratio. Some composting sites also add (solid fraction of) digestate, vegetal biomass or vegetable, fruit and garden (VFG) waste or green waste compost.

Compost contains high organic carbon load as well as P which can be considered more slow-release (EIP-AGRI Focus Group 2017).

#### **2.2.7.1 Energy requirements**

Estimations amount to 50 kWh per ton for large-scale intensive composting in a closed system (R. Melse et al. 2004).

Others estimated that intensive composting (forced ventilation) of 600 ton manure per year consumed 1980 kWh electricity per year and 480 liter fuel (EC-JRC 2017).

#### **2.2.7.2 Costs**

The OPEX will vary depending on the composting technique to be used. For a hygienisation drum, processing costs of about 15 euro/tonne solid fraction are assumed (Gorissen and Snauwaert 2018). (R. Melse et al. 2004) estimated up to 35€/ton for intensive composting.

The composting process is technically quite simple, but requires effective follow-ups or monitoring (temperature, oxygen and moisture content). The quality and maturity of the finished products are often in proportion to the efforts made (Gorissen and Snauwaert 2018).

## 2.2.8 Phosphorus precipitation

### 2.2.8.1 Technology description

Several ions can be added to a solution containing soluble phosphate (orthophosphate) to induce a precipitation reaction forming phosphate salts.

Phosphorus recovery from digestate as struvite (magnesium ammonium phosphate (MAP);  $\text{MgNH}_4\text{PO}_4 \cdot 6 \text{H}_2\text{O}$ ) precipitation is already proven on full scale (VCM 2018b).  $\text{CO}_2$  stripping by blowing air in the reactor elevates the pH to 9-11 and shifts the reaction equilibrium to struvite:

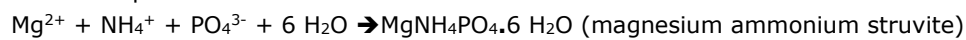

Addition of  $\text{MgCl}_2$ ,  $\text{Mg}(\text{OH})_2$  or  $\text{MgO}$  or  $\text{KCl}$  or  $\text{KOH}$  respectively is necessary because digestate usually does not contain the required magnesium/ammonium or potassium/phosphate ratio's to promote a controlled struvite precipitation in the reactor.

From their solubility constants, it can be deduced that if both ammonia and potassium are present in excess,  $\text{Mg-NH}_4$ -struvite will precipitate instead of  $\text{K}$ -struvite. Therefore,  $\text{K}$ -struvite will be only precipitate if the excess of potassium is much higher than ammonium (D Fangueiro et al. 2011).

Addition of calcium to a phosphate solution will form calcium phosphate. However, calcium phosphate precipitation is very complex and involves various parameters: calcium and phosphate ions concentration, ionic strength, temperature, ion types, pH and reaction time (Desmidt et al. 2015). When calcium hydroxide ( $\text{Ca}(\text{OH})_2$ ) is added to the liquid fraction and the pH increases above 10, and temperature ( $70^\circ\text{C}$ ), phosphorus precipitates as hydroxyapatite ( $\text{Ca}_5(\text{PO}_4)_3\text{OH}$ ) or brushite ( $\text{CaHPO}_4 \cdot 2\text{H}_2\text{O}$ ). Depending on dosage, three different  $\text{Ca}$ -phosphates can be obtained: the highly water-soluble mono-calciumphosphate (MCP), the citric acid soluble di-calciumphosphate (DCP) and the barely soluble tri-calciumphosphate (TCP). For fertiliser application, MCP and DCP are favoured (D Fangueiro et al. 2011).

### Configurations

There are many different types and brands of struvite precipitation reactors available on the market.

### 2.2.8.2 Recovery efficiency

The Airprex® system (CNP) on raw digestate from waste water treatment sludge (Outreach Location Waternet Amsterdam West, The Netherlands) is able to reduce the ortho-phosphate concentration from 250 mg  $\text{PO}_4\text{-P}$  /L to 4 mg  $\text{PO}_4\text{-P}$  /L. This is a 75% recovery of  $\text{PO}_4\text{-P}$  as struvite (Veltman 2012).

### Addition of chemicals

Struvite is mostly formed by adding  $\text{MgO}$  or  $\text{MgCl}_2$ . The main advantage of  $\text{MgCl}_2$  is that its production requires less energy.

Main disadvantages are a slower and less complete reaction, no pH increase as well as the presence of chloride ions in the remaining digestate (Sanders and Kasteren 2010).

### Combination with other technologies (pre-treatment and post-treatment)

Generally, struvite precipitation is done on (liquid fraction of )digestate, mainly from activated sludge from waste water treatment, because of the high P levels and their composition and operational conditions stimulating struvite precipitation. Important is the amount of total suspended solids (TSS) in the influent to the struvite reactor, which may affect struvite quality as struvite crystallization is governed by several interacting parameters including, amongst others, influent P-concentration, crystal retention time, TSS concentration, viscosity, presence of colloidal substance,  $\text{Mg:P}$  ratio, pH and mixing

conditions (Doyle et al. 2002). As a result, the produced struvite is likely to vary in crystal size, presence of co-precipitates and inclusion of organics and other contaminants (Muys et al. 2021).

### Composition of the end products

When MgCl<sub>2</sub> or KCl is used, the remaining digestate can only be valorised as a fertiliser for crops that are tolerant for chloride ions, e.g. grass (Sanders and Kasteren 2010). For digestate from sewage sludge, the use in agriculture is prohibited in some member states.

#### 2.2.8.3 Energy requirements

Table 2-42 gives an estimation of the energy requirements for struvite precipitation from digested sewage sludge. The energy consumption can of course vary depending on the system used, the type of digestate, operational conditions etc.

Table 2-42 Indicative values for energy consumption of the AIRPREX system on digested sewage sludge.

	kWh per m <sup>3</sup> sludge	Technology
(Ewert et al. 2014)	0.23	AirPrex-Berlin, Wassmannsdorf 1'820 m <sup>3</sup> /d digested sludge with 3.5 % TS
(Ewert et al. 2014)	0.9	AirPrex-MG, Neuwerk 1'200 m <sup>3</sup> /d digested sludge with 3.9% TS

#### 2.2.8.4 Costs

Capital costs based on budget proposals were estimated at 2.300-24.500€ /kg P/day (Vaneckhaute 2015).

Operational costs are highly dependent on the input composition (e.g. available P, Mg, and pH) as it determines the chemical (NaOH, Mg) and energy costs. (Battistoni et al. 2002, 2005) estimated operating costs at 0.19-0.28 €/m<sup>3</sup> digestate.

Generally, it can be argued that chemical costs are high (Table 2-43).

However, struvite recovery can be economical on digested sewage sludge with a P load of more than 20 % by weight, because this cost can be balanced with reduced costs in additives (iron (Fe) / aluminium (Al)) for dewatering of the digested sewage sludge and maintenance prevented due to unwanted struvite precipitation in piping and equipment (Vaneckhaute 2015; Veltman 2012).

Table 2-43 Indicative prices for chemicals used in P precipitation (Regelink et al. 2019)

Product	Price
45% (w/w) Ca(OH) <sub>2</sub> suspension	€100-130 per ton
55% (w/w) Mg(OH) <sub>2</sub> suspension	€250,- per ton
99% (w/w) magnesium oxide (MgO) powder	€300,- per ton
MgCl <sub>2</sub>	< Mg(OH) <sub>2</sub>

## 2.2.9 Phosphorus solubilisation and precipitation

Different research centres and technology suppliers have been pilot testing an acid-alkaline treatment process to extract organically bound phosphorus from digestate or manure.

By adding acid to it, the pH will drop, releasing complexed or organically bound  $P_2O_5$  in the liquid phase. By a second liquid-solid separation, a P-poor organic soil improver and a P-rich liquid fraction are created. After adding alkali the latter, phosphate salts can be recovered after precipitation, sedimentation and drying.

The main aim of extracting phosphorus from digestate is to reduce the P content and subsequently avoid long distance transport to export P out of P surplus areas. This would allow more organic material to be applied on agricultural land in the nearby region while not exceeding stringent P application rates.

Most of these systems are now in the next phase, upscaling to full scale.

### 2.2.9.1 Recovery of P to eat (RePeat)

#### 2.2.9.1.1 Technology description

The RePeat (Recovery of P to eat) process is an acid-alkaline approach to separate solid fraction of digestate into a low-P soil improver and precipitated phosphate salts. The concept has been developed by Wageningen University and Research (Wageningen, The Netherlands) and Nijhuis Industries (Doetinchem, The Netherlands)

The Repeat installation (Figure 2-25) consist of the following units:

- Acidification tank where solid fraction is mixed with process water and sulphuric acid
- Screw press 1 – leaching step 1
- Screw press 2 – leaching step 2
- Lamella clarifier to remove fines from the acid liquid fraction
- Precipitation reactor
- Settling tank to separate the precipitated P

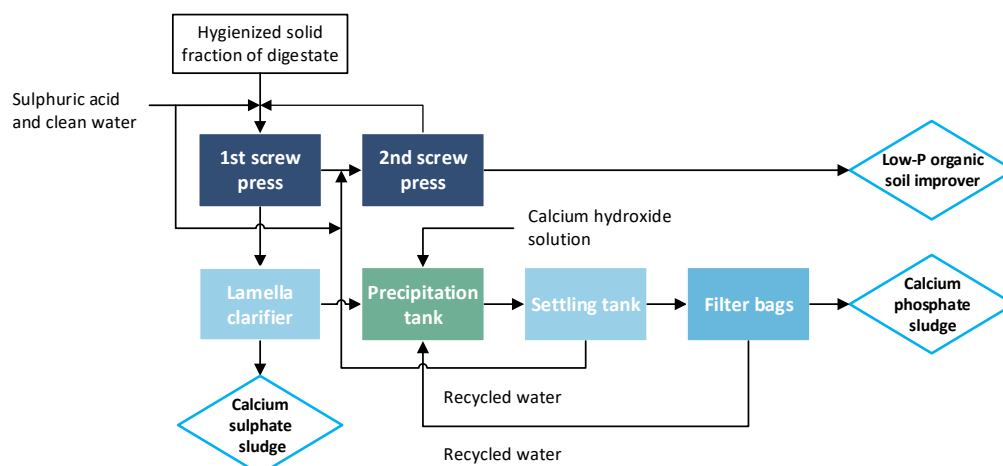

Figure 2-25 Process scheme of the RePeat installation at GZV (as configured in May 2020) (Brienza et al. 2020)



The solid fraction of co-digested pig manure after decanter centrifuge is diluted with process water that remains after the after the second leaching step (screw press 2). This way the solid fraction is liquid enough to be pumped to the acidification tank. There the pH of the slurry is lowered to pH 5.5 through addition of 98% H<sub>2</sub>SO<sub>4</sub> and the slurry is thereafter separated into a solid fraction and a liquid fraction by means of the first screw press. The solid fraction is thereafter again mixed with process water (with a low P content), acidified to pH 5.5 and dewatered in the second screw press. This second leaching step removes residual P from the solid matrix, ensuring a high P removal efficiency.

The liquid fraction after screw press 1 contains about 3000 mg/L of P mostly as ortho-phosphate (P-PO<sub>4</sub>) and is treated by a lamella clarifier to remove fine organic matter prior to feeding it into the precipitation tank. In the precipitation tank, phosphate precipitation is induced by increasing the pH to 7.0 through addition of a 45% Ca(OH)<sub>2</sub> suspension. The precipitation tank is continuously mixed by means of aeration and a screw. The volume of the precipitation tank (>30 m<sup>3</sup>) is large enough to ensure a hydraulic retention time of five hours.

The effluent of the precipitation tank is fed into a settling tank where the precipitated P salt is separated from the liquid based on difference in density. The sludge of the settling tank has a dry matter content of about 20%. The effluent of the settling tank is poor in phosphorus and recycled back to the second screw press. The calcium phosphate salt sludge is pumped into a storage tank. An additional treatment step to increase the dry matter content of the slurry is foreseen. An alternative route also currently under development, is investigating the feasibility of P precipitation as struvite by adding Mg(OH)<sub>2</sub> instead of Ca(OH)<sub>2</sub> (Figure 2-26).

## Development

As of January 2020 the process is operational at full scale (2 m<sup>3</sup> solid fraction/hour) at Demo Plant Groot Zevert Vergisting, the Netherlands. Currently it is running for about 6 hours a day. Technically it is designed to run 24 hours a day in order to treat all the solid fraction produced at Groot Zevert (16.000 tons/year). However, upgrading to full treatment capacity will depend on the profitability of the newly produced end-products: the low-P soil improver and the precipitated phosphate salts. As by the end of 2020, the full scale installations has so far only been operated with the of liquid Ca(OH)<sub>2</sub> and hence there is no practical experience yet with production of struvite.

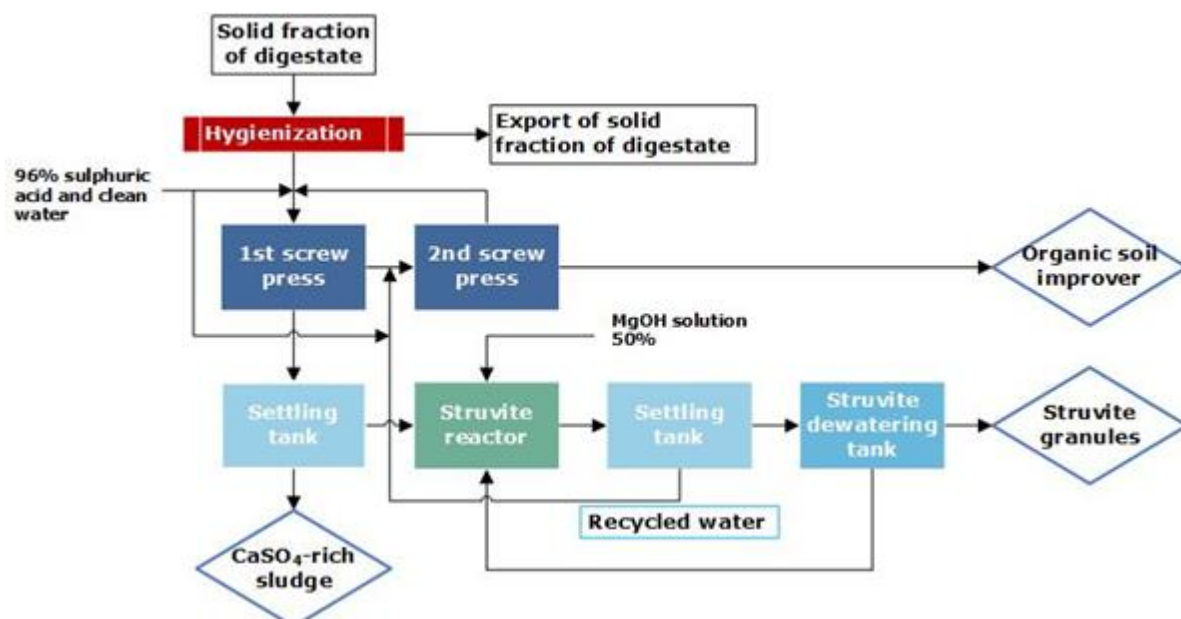

Figure 2-26 Configuration of RePeat as to commence production in January 2020

### 2.2.9.1.2 Recovery efficiency

A mass balance was derived for the full scale installation over a period of three months (November 2020-Januari 2021) (Table 2-44). Feedstock of the installation was SF of digestate obtained by a decanter.

The RePeat cascade removed 80-85% of total phosphorus content from the ingoing SF thereby reducing the P content of the ingoing solid fraction from 8.8 g P/kg to less than less than 2 g P/kg. The S content increased to 4.5 g/kg due to the use of sulphuric acid. The precipitated phosphate salts are recovered as a sludge and an additional drying step would be required in order to reduce the volume of this stream. Currently, precipitated phosphate salts are sold as a slurry to arable farmers in The Netherlands. Further improvements including dewatering of the Precipitated phosphate salts are foreseen.

Additionally, the RePeat installation produces some sludge which originates from the lamellae clarifier that removes fine particulates from the liquid acid fraction. At GZV, the sludge is fed back into the digester and hence considered an intermediate stream.

*Table 2-44 Separation efficiency of the settling tank and composition of the end products produced in the RePeat cascade at at Groot Zevert Vergisting.*

*DM = dry matter, OM = organic matter, Total N = total nitrogen, NH<sub>4</sub>-N = ammonium nitrogen, Total P = total phosphorus, Total K = total potassium, Total Ca = total calcium, Total Mg= total magnesium, Total S= total sulphur, CAP= Calcium phosphate*

		Feedstock	End products	intermediate	End product	
<b>1</b>		Solid fraction digestate	Low-P soil improver	Precipitated CAP salts sludge (not dewatered)	Sludge lamellae clarifier (to digester)	Dried Phosphate salts sludge
Mass	kg	1000	750	650	393	
DM	g kg <sup>-1</sup>	319	295	170	80	900
OM	g kg <sup>-1</sup>	247	265	83	48	424.3
Total N	g kg <sup>-1</sup>	12	5.7	8.0	4.6	
NH <sub>4</sub> -N	g kg <sup>-1</sup>	6.2	1.7	5.0	3.2	
Total P	g kg <sup>-1</sup>	8.8	1.6	11	3.2	47.1
Total K	g kg <sup>-1</sup>	4.4	1.5	2.1	2.7	12.8
Ca	g kg <sup>-1</sup>	6.0	4.2	13	2.5	
Mg	g kg <sup>-1</sup>	6.2	1.2	4.6	2.4	
S	g kg <sup>-1</sup>	2.0	4.5	9.4	7.8	7.1

<sup>1</sup> GZV November 2020-Januari 2021

### Use of additives

Sulphuric acid was used to decrease the pH of the SF in order to dissolve P. The acid consumption rate of the full scale plant amounted to 25 L of 98% sulphuric acid. In the full scale installation, calcium hydroxide was used to increase the pH in the precipitation tank. The consumption of 45%Ca(OH)<sub>2</sub> varied between 20 – 40 kg per ton treated solid fraction during three months of monitoring of the full scale plant in 2020. Alternatively, magnesium-hydroxide can be used which would results in the formation of struvite instead of brushite. In the laboratory, 29 L (35 kg) of 55% (w/w) Mg(OH)<sub>2</sub> solution was needed per ton of solid fraction and this dosage has not yet been confirmed with full scale tests This amount was needed to maintain the pH in the precipitation beaker above 7.5 which was found to be sufficient for a nearly complete P removal.

Table 2-45 Amount of sulphuric used to acidify the solid fraction. Adapted from (Regelink et al. 2019) SF=solid fraction

	96% sulphuric acid (L/ton SF)
<sup>1</sup> Lab results 2017	17
<sup>2</sup> Pilot tests 2017	22
<sup>3</sup> Pilot tests 2018	32
<b>Average</b>	24

1 (Schoumans et al. 2017)

2 Solid fraction was twice acidified (Regelink et al. 2019)

3 Average of 4 batches, solid fraction was acidified once. Solid fraction was used with a P content of 11 g/kg. This content is far above the normal P content of about 6-8 g/kg.(Regelink et al. 2019)

## Composition of the end products

The nutrient contents of the end products of the RePeat cascade can be found in Table 2-44. The low-P soil improver has a P content of 2 g/kg and an OM to P ratio of 160 kg OM/kg P meaning that farmers can apply relatively large amounts of OM without exceeding the P application rate limits. The S content of the low-P soil improver amounts to 4.5 g/kg which is higher than the ingoing solid fraction due to the use of sulphuric acid. Sulphur is a macro-nutrient but dosages above the crop uptake rate should be prevented. Therefore, also the S content of the low-P soil improver should be taken into account in the farmers fertilisation plan.

### 2.2.9.1.3 Energy requirements

Energy consumption of the full scale plant amounted to 3.1 kWh/ton ingoing SF.

### 2.2.9.1.4 Storage capacity

The full-scale installation for treatment of 16.000 ton SF per year covers a surface area of about 200 m<sup>2</sup>. This is required for tanks, separators and reactor vessels. Storage capacity for end products is limited to about 40 m<sup>3</sup> for the low-P soil improver and 20 m<sup>3</sup> for the precipitated phosphate salts which is only sufficient to store the end products for a few days to weeks. End products are brought to end users on a day-to-day basis and hence there is no need for larger storage capacity on-site.

### 2.2.9.1.5 Costs

#### The capital investment expenditures (CAPEX)

The estimated investments cost for a second installation (without development costs) is estimated on € 600.000 -1 million € for a treatment capacity of 16.000 tons per year.

#### The operational expenditures (OPEX)

##### Cost for manhours

Groot Zever Vergisting estimates that an operator needs 3 hours/day working on the RePeat system. This includes mostly monitoring if the installation runs well, because it is fully automated. Other task could be: checking if there is enough Ca(OH)<sub>2</sub>, checking the levels of the tanks and fixing small issues or disturbances.

##### Cost of maintenance

Costs for maintenance and spare parts are estimated at 1% of the investment costs(Brienza et al. 2019).

##### Cost of chemicals

In the RePeat stripper, H<sub>2</sub>SO<sub>4</sub> and base are used as additives. The base can be either Ca(OH)<sub>2</sub> or Mg(OH)<sub>2</sub>. The latter is more expensive but has advantages in terms of dewaterability of the precipitated Phosphate salts compared to the use of Ca(OH)<sub>2</sub>. Lower grade by-products of industrial processes can be used, which can be financially attractive. The estimated costs for processing a tonne of SF are shown in Table 2-46 based on average and high prices of the required chemicals.

Table 2-46 Costs of chemicals to be used on RePeat. Based on (Brienza et al. 2019; Regelink et al. 2019)

Chemical commodity	<sup>1</sup> Quality	Price Range € t <sup>-1</sup>	Dosage kg t <sup>-1</sup> SF	€ t <sup>-1</sup> SF
Sulphuric acid	Industrial, bulk, 96%	92	26	€2.40
Calcium hydroxide (Neutralac)	Industrial, bulk, 45%	120	30	€ 3.60
Magnesium hydroxide	Industrial, bulk, 55%	250	35	€ 8.75
MgO	Industrial, bulk, 99%	300	11	€3.30

<sup>1</sup> Source: Brenntag Nederland B.V. (personal communication with Dutch suppliers).

## 2.2.9.2 BioEcoSIM

### 2.2.9.2.1 Technology description

In the framework of the FP7-EU-BioEcoSIM project, the German research centre Fraunhofer IGB developed a technology cascade to recover phosphorus from manure and digestate. The process consists out of the following steps (Figure 2-27):

- Homogenisation and conditioning
- Phosphorus recovery
- Nitrogen recovery
- Hygenisation: Drying/pyrolysis

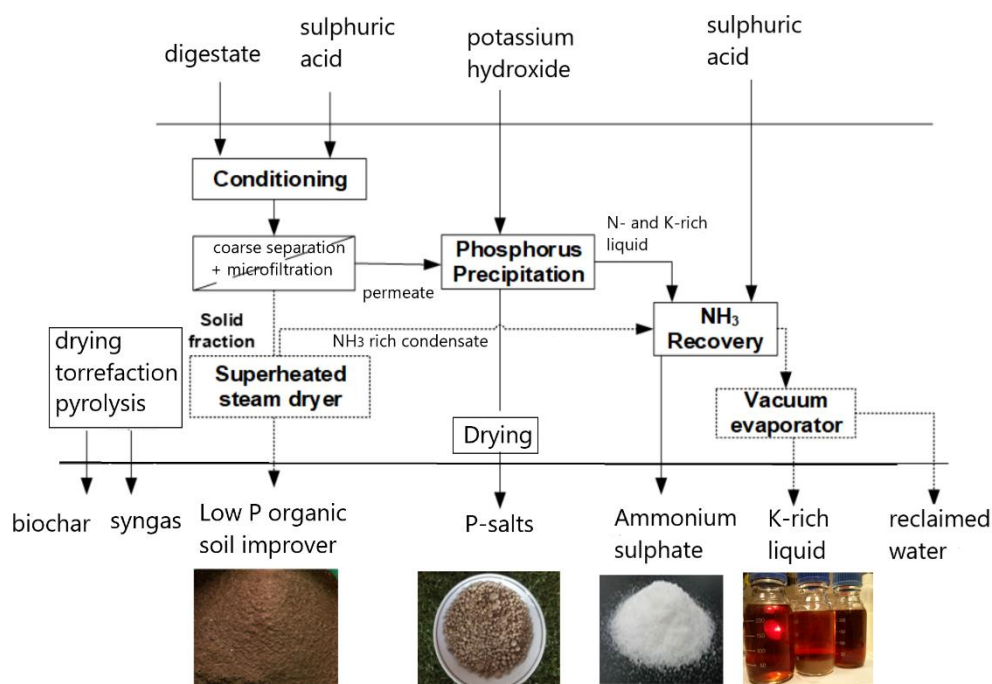

Figure 2-27 Process steps from the BioEcoSIM process. Adapted from: presentation Egner, S. ManuREsource conference 2019 and (Fraunhofer IGB 2021)

### Homogenisation and conditioning

The digestate is homogenised and conditioned by acid leaching, so that phosphorus is completely dissolved. Addition of acid (e.g. sulphuric acid) will lower the manure pH to 5 to 6. The acidified digestate is then separated into a solid and a liquid phase via a multi-stage filtration. This includes a including a robust, low-energy and effective microfiltration developed by Fraunhofer without the addition of expensive coagulants or any other additives.

The output of the microfiltration is a particle-free solution rich in NH<sub>4</sub><sup>+</sup> and P (Fraunhofer IGB 2021).

### ***Phosphorus recovery***

Once solids have been removed, the liquid fraction contains the dissolved inorganic nutrients. Phosphorus is first recovered in a reactor at pH 8-9 and precipitated as calcium phosphate, magnesium phosphate and struvite and K-struvite as crystals and filtered off. For the crystallisation, only KOH to raise the pH will be used, as acidified digestate liquid fraction contains high concentrations of Mg and Ca (Fraunhofer IGB 2021).

### ***Nitrogen recovery***

Nitrogen is recovered in a robust and broadly implemented system for ammonia stripping and scrubbing. The scrubber water (ammonium sulphate solution) is separated as ammonium sulphate solution by membrane adsorption which is crystallised.

### ***Hygienisation***

The acidified solid phase is dried by using an energy-efficient process developed at Fraunhofer IGB, superheated steam drying. The dried organic components can optionally be torrefied with this process at approx. 250 °C or converted to biochar via a pyrolysis step at 450 °C (Fraunhofer IGB 2021).

### **Development**

The BioEcoSIM concept reached a mature development stage (TRL 5) since it was successfully validated at a pilot scale of 50 kg/h for over 15 months on a farm located in Kupferzell, Germany. Based on these results, a new prototype of the modules: (conditioning, solid-liquid separation and P-recovery) with a capacity of 1 tonne/h was developed, built and demonstrated (2016-2017) during the PhosKa-Demo project financed by the German Ministry of Education and Research. In this project specially the crystallisation of the P-fertilisers was substantially improved. However, it was noticeable, that raw fertiliser materials need a further processing as to e.g. granulation to achieve the market.

In 2018-2019, a prototype has running at Zorbau, Germany to validate all integrated modules of the technology (treatment capacity of 1-2m<sup>3</sup>/h). It will serve as a blueprint for further large-scale plants.

The BioEcoSim technology has been licensed by the project partner Suez Deutschland GmbH, a wastewater treatment and waste management company, who will distribute the patented technology in Europe. SUEZ Deutschland will build BioEcoSim plants in Western Europe and, as the operator of the plants, will purchase digestate from agricultural enterprises. Fraunhofer IGB supports SUEZ Deutschland in the further development of the process. The R&D has achieved a technological shift up to TRL 8 and the planning and design of plants across Europe with a capacity of about 20 m<sup>3</sup>/h each has started (presentation Siegfried Egner, ManuReSource Conference, Hasselt,Belgium, November 28th, 2019).

### 2.2.9.2.1 Separation efficiency

For the solubilisation of almost all the P content in pig manure digestate the pH value has to be adjusted to 2. To avoid the use of large quantities of acid, it was decided that the anaerobic digestate pH was adjusted to 4. With this, there is a P recovery potential of 65% for digestate.

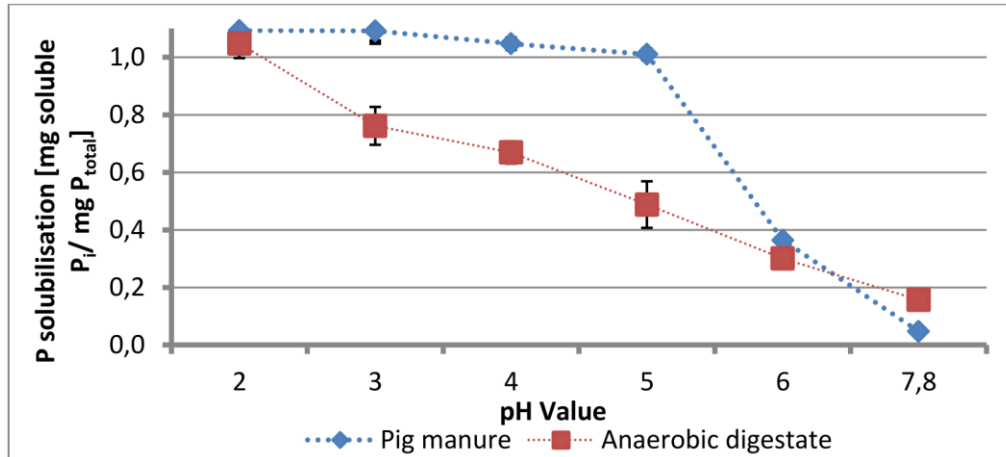

Figure 2-28 P solubilisation experiment on pig manure and digested pig manure. Source: (Campos and Bilbao 2015)

Eventually, 39.6% of the total P in the raw digestate was recovered as Phosphate salts. This is 94% of the total soluble P after acidification (Campos and Bilbao 2015).

### Combinations with other NRR technologies

The system treats the P poor digestate with ammonia stripping-scrubbing technology to recover the nitrogen as ammonium sulphate solution.

### Chemical consumption

The acid consumption for the acidification of the samples at different pH values was also determined (Table 2-47). As expected, the quantity of acid used increase with decrease in the pH value.

The **quantity of acid needed** for each type of residue depends not only on the initial pH value but also on other chemical and physical characteristics of each residue. For example, one important parameter is the concentration of buffer substances, such as carbonates. The concentration and type of organic substances could also have an effect on the quantity of acid needed to adjust the pH value.(Campos and Bilbao 2015)

Table 2-47 Quantity of  $H_2SO_4$  (60%) need to acidify digestate from pH 7.9 to different pH values. (Campos and Bilbao 2015)

pH	Quantity of $H_2SO_4$ (60%) added ml/kg digestate
6	24.8±2.0
5	26.1±1.3
4	29.4±2.0
3	32.8±3.3
2	38.8±2.7

Density of  $H_2SO_4$  60% at 25°C: 1.494 g/ml

The pH value was adjusted to 9 by **addition of a sodium hydroxide** solution 45%. The quantity of base needed was about 4.2 ml/kg permeate (6.3 g/kg) (microfiltration) for anaerobic digestate.

## Composition of the end products

Table 2-48 Composition of the end products of the BioEcoSIM process on digested pig manure.

DM = dry matter, OM = organic matter, TOC=Total Organic Carbon, Total N = total nitrogen, NH<sub>4</sub>-N = ammonium nitrogen, Total P = total phosphorus, Total K = total potassium, Total Ca = total calcium, Total Mg= total magnesium

		<sup>1</sup> Phosphate salts	<sup>1</sup> Steam-dried separated solids	<sup>1</sup> Air-dried separated solids	<sup>2</sup> Phosphate salts air dried	<sup>2</sup> Effluent after P salt precipitation
DM	g kg <sup>-1</sup>	697	916	954		<10
OM	g kg <sup>-1</sup>					
TOC	g kg <sup>-1</sup>	358				
Total N	g kg <sup>-1</sup>				36	
NH <sub>4</sub> -N	g kg <sup>-1</sup>				28	3
Total P	g kg <sup>-1</sup>	107	23	21		
Water soluble P (PO <sub>4</sub> -P)	g kg <sup>-1</sup>	1.3	3.5	3.5	128	0.038
Total K	g kg <sup>-1</sup>				14	2.94
Ca	g kg <sup>-1</sup>				66	0.217
Mg	g kg <sup>-1</sup>				51	0.001

1 (Ehmann et al. 2019) P-salts recovered from acidified digestate. Dried solids were obtained from untreated digestate by solid-liquid separation and dried with warm air at 40°C or with superheated steam at 120°C.

2 (Campos and Bilbao 2015) Phosphate salts dried at room temperature. Liquid fraction after precipitation of Phosphate salts/

### 2.2.9.2.2 Costs

In 2015, a rough cost-benefit estimation of BioEcoSIM has been made with the results available at the time (Campos and Bilbao 2015).

#### The capital investment expenditures (CAPEX)

The capital costs for a plant treating 60 000 ton of digestate including its material, design, engineering and control system were estimated to be 800 000 EUR.

#### The operational expenditures (OPEX)

The total operating costs of treating the digestate with the Fraunhofer technology were estimated at 543 448 EUR, which means a specific cost per ton of digestate of 9,06 EUR. Considering the revenues of the best case scenario (276 600 EUR) and worst case scenario (10 200 EUR), the total specific net costs of the process is about 4,45 to 8,89 EUR per ton digestate treated (Table 2-49, Table 2-50).

Table 2-49 Rough cost-benefit estimation of the BioEcoSIM technology to treat 60.000 ton of digestate per year (best case scenario). (Campos and Bilbao 2015).

Item	Unit	Quantity	Unit Price	Annual Costs
<b>Costs</b>				
<b>Capital costs</b>				
Materials, Engineering, Commissioning, Automation	€	1	800 000,00 €	
Interest (5%): Loan for 10 years				22 000,00 €
Depreciation costs (12 years)				66 000,00 €
<b>Operating costs</b>				
Sulfuric acid 60%	m <sup>3</sup> /a	1764,00	122,00 €	215 208,00 €
Base (99%)	Ton/a	100,8	300,00 €	30 240,00 €
Energy	MWh/a	900,00	140,00 €	126 000,00 €
Maintenance	€	-	3%	24 000,00 €
Disposal of solid fraction in Flanders	Ton/a	12 000,00	5,00 €	60 000,00 €
<b>Total operating costs</b>	<b>€/a</b>			<b>543 448,00 €</b>
<b>Specific operating costs</b>	<b>€/m<sup>3</sup></b>			<b>9,06 €</b>
<b>Revenue</b>				
P-Salts	ton/a	204,00	400,00 €	81 600,00 €
Liquid fertilizer (N, K)	ton/a	39000,00	5,00 €	195 000,00 €
<b>Total revenues</b>	<b>€/a</b>			<b>276 600,00 €</b>
<b>Net costs</b>	<b>€/a</b>			<b>266 848,00 €</b>
<b>Specific net costs</b>	<b>€/m<sup>3</sup></b>			<b>4,45 €</b>
<b>Savings</b>				
Fees for digestate disposal	m <sup>3</sup> /a	60 000,00	20,00 €	1 200 000,00 €
<b>Net Savings</b>	<b>€/a</b>			<b>933 152,00 €</b>

#### Assumptions

- Maintenance: 3% from capital costs
- Quantity of solid fraction to be disposed is 20% of the total mass of digestate
- Quantity of the liquid fertilizer is 65% of the total mass of digestate



Table 2-50 Rough cost-benefit estimation of the BioEcoSIM technology to treat 60.000 ton of digestate per year (worst case scenario). (Campos and Bilbao 2015)

Item	Unit	Quantity	Unit Price	Annual Costs
<b>Costs</b>				
<b>Capital costs</b>				
Materials, Engineering, Commissioning, Automation	€	1	800 000,00 €	
Interest (5%): Loan for 10 years				22 000,00 €
Depreciation costs (12 years)				66 000,00 €
<b>Operating costs</b>				
Sulfuric acid 60%	m <sup>3</sup> /a	1764,00	122,00 €	215 208,00 €
Base (99%)	Ton/a	100,8	300,00 €	30 240,00 €
Energy	MWh/a	900,00	140,00 €	126 000,00 €
Maintenance	€	-	3%	24 000,00 €
Disposal of solid fraction in Flanders	Ton/a	12 000,00	5,00 €	60 000,00 €
<b>Total operating costs</b>	<b>€/a</b>			<b>543 448,00 €</b>
<b>Specific operating costs</b>	<b>€/m<sup>3</sup></b>			<b>9,06 €</b>
<b>Revenue</b>				
P-Salts	ton/a	204,00	50,00 €	10 200,00 €
<b>Total revenues</b>	<b>€/a</b>			<b>10 200,00 €</b>
<b>Net costs</b>	<b>€/a</b>			<b>533 248,00 €</b>
<b>Specific net costs</b>	<b>€/m<sup>3</sup></b>			<b>8,89 €</b>
<b>Savings</b>				
Fees for digestate disposal	m <sup>3</sup> /a	60 000,00	20,00 €	1 200 000,00 €
<b>Net Savings</b>	<b>€/a</b>			<b>666 752,00 €</b>

**Assumptions**

- a. Maintenance: 3% from capital costs
- b. Quantity of solid fraction to be disposed is 20% of the total mass of digestate

### 2.2.9.3 NutriSep

During the BioEcoSIM project, Geltz Umwelttechnologie GmbH was the partner constructing the demo installation. Today, they are further developing the technology separately from Fraunhofer IGB.

#### 2.2.9.3.1 Technology description

The pilot plant (1m<sup>3</sup>/h), called PhoskaDEmo was running during the BioEcoSIM project at the Biogas Plant AgroEnergie Hohenlohe, in Kupferzell, Germany. Geltz has now built the upscaled version treating 10 m<sup>3</sup>/h or about 70.000 m<sup>3</sup>/a, called the "NuTriSep™" at the same location (presentation Geltz at IBBK conference on manure & digestate valorisation, 2021).

#### 2.2.9.3.1 Separation efficiency

#### Composition of end products

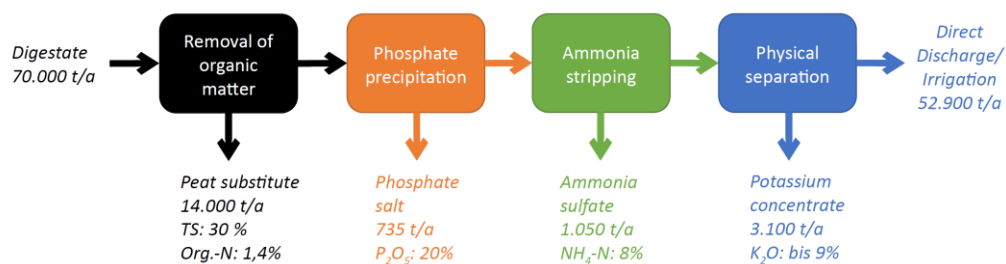

Figure 2-29 Estimated composition of the produced products with the NutriSep process. Source: presentation Geltz at IBBK conference on manure & digestate valorisation, 2021)

#### Combinations with other NRR technologies

The system treats the P poor digestate with ammonia stripping-scrubbing technology to recover the nitrogen as ammonium sulphate solution.

#### 2.2.9.3.2 Costs

Table 2-51 gives an overview of the estimated cost breakdown of the NutriSep process for treatment of 70,000tons/year, 10 years depreciation.

Table 2-51 Estimation of the CAPEX and OPEX of the NutriSep process treating 70,000tons of digestate per year. Adapted from: presentation Geltz at IBBK conference on manure & digestate valorisation, 2021

<b>CAPEX (€)</b>	2,000,000
<b>Depreciation (€/year)</b>	200,000
<b>OPEX</b>	
<b>Consumables (€/year)</b>	360,000
<b>Interest (% of CAPEX)</b>	2
<b>Energy CHP unit (€/year)</b>	125,000
<b>Personnel</b>	1 fulltime
<b>Maintenance (€/year)</b>	120,000
<b>Insurance (€/year)</b>	20,000

## 3. Discussion and conclusions

### 3.1 Technologies and cascades to be included in the NUTRICAS Tool

Based on the information in the previous chapter, the following technologies are regarded as NRR techniques (Criterion 1) for digestate and are currently applied in full-scale at biogas plants (Criterion 2). They will therefore be included in the NUTRICAS Tool.

**Liquid-solid separation** of digestate creates 2 end products: a solid fraction with higher dry matter and phosphorus concentrations compared to the raw digestate and a liquid fraction with most of the soluble minerals.

The separated solids can be applied directly for agricultural purposes, with the advantage of improved storage and considerably lower transport costs due to the reduced water content.

Although the concentration factor of the nutrients from the digestate to these end products is not extremely high, it can still be considered as an indispensable technology that facilitates further concentration of the nutrients through consecutive steps.

**Thermal drying** can further concentrate the nutrients in the solid fraction, reduce the volume and improve the texture (e.i. powdery).

The **technology of ammonia stripping-scrubbing** is able to concentrate a large part of the ammonia nitrogen from the digestate into a stable ammonium salt solution. The N stripped digestate can therefore be applied on agricultural land with less risk of ammonia emission and leaching. Also, larger volumes can be applied (compared to raw digestate) before reaching the N application limits.

**Membrane technologies** like reverse osmosis are also able to recover the nutrients in a liquid concentrate. However, the concentration factor remains low, because it is generally one of the final steps in concentrating the liquid fraction of digestate. Permeate water can be of discharge quality after a final polishing step.

**Evaporation** is an efficient way to reduce the volume and water content of the liquid fraction of digestate and re-use heat from the CHPs. The condensated (ammonia) water does not contain concentrated nutrients, but is not clean enough for discharge. The concentrate after evaporation is a slurry with concentrated nutrients. However, it cannot be used as such as a fertiliser.

**Phosphorus solubilisation and precipitation** is able to create two end products will added value: phosphorus salts with a slow-release characteristics and a P-low soil improver. However, there are some intermediate products (P stripped liquids with various low P concentrations) and by-products (i.e.  $\text{CaSO}_4$  sludge) that need to be recycled in the process or safely and economically disposed of.

The process of **biothermal drying** is not included in NUTRICAS Tool, because it is mere a stabilisation process of organic matter, which only marginally concentrates the nutrients in the final product. Also, it is not applied on (solid fraction of) digestate as such, but on mixtures with solid manure and other bio-waste. Practically, it is also extremely difficult to develop a simplified calculation model for the mass balance, since it is a biological process which is influenced by many factors: the composition of the product entering the composting process, the time of composting, air supply, temperature achieved by the bacteria, etc. and recovery rates are therefore highly variable.

**The struvite precipitation** cascade is also not included in the NUTRICAS Tool, because it involves complex chemical reactions depending on various conditions (e.g. ions

concentration, ionic strength, temperature, ion types, pH and reaction time), which cannot be generalized in a simple calculation model based on the data available. Additionally, the purity of the precipitated phosphorus salts is highly dependent on the pre-treatment (separation step) before the precipitation reactor. Also, it is generally only advised for phosphorus rich digestate, with high soluble P, like digested sewage sludge.

## 3.2 Cost-efficiency of the technology cascades

According to the given goal of recovering and concentrating the nutrients and organic matter, individual process steps have to be combined into an overall treatment concept. For this there exists no standard blue-print and instead a wide variety of **technology cascades** are possible. Examples of cost estimations of the technology cascades from the SYSTEMIC Demo Plants are given in Table 4-1.

In general, it can be concluded that all above mentioned technologies (except from separation) are complex, high-tech and frequently require the input of chemicals (acids, alkali, anti-scalants, anti-foam).

The more technologies are included in a cascade, the **more different material and product flows need to be managed properly**. When setting up a business plan with NRR on digestate, one should therefore include the safe (re-)use of all produced end- and by-products, preferable economically beneficial for the biogas plant. This has to be considered, before going further in the selection of technologies.

Estimations for **OPEX** are difficult because they depend on different factors. Additionally, in this report the OPEX often contains different cost items (labour cost, maintenance costs, etc.) or information on cost break-down is missing.

Operating a complex NRR technology cascade requires skilled operating personnel, who are adequately trained in technical operations, chemical processes and safety procedures. This requires a **cost for training and labour**, which can differ regionally and can even be case-specific. Next to that, CAPEX and OPEX (labour costs) also greatly depend on the degree of automatization of the process.

Also, **equipment maintenance cost** depends highly on the operational conditions, the type of feedstock etc., making this very case-, technology provider- and country specific.

This makes it difficult to compare the different OPEXs of the same technology. Furthermore, when technologies are combined into cascades, this can positively influence the recovery rate of the consequent step, resulting in a decrease in OPEX for this step.

**Energy consumption and heat consumption** are important cost determining factors. Values for technology energy consumption and heat consumption per ton digestate treated are very difficult to obtain. This is because most (demo) biogas plants don't monitor energy consumption per process unit in kWh/ton influent, but globally for the whole plant per year in the best case. Energy consumption of a technology is most likely depended on many factors like technology supplier and energy re-use efficiency, efficiency of heat transfer, which are not covered by this report. In general, the costs for electricity consumption are usually minor as compared to the overall costs of treatment. Both CAPEX and OPEX greatly depend on the amount of heat energy from the CHP and the process that can be re-used in the NRR technology cascade.

**Chemical use** can be a high cost item in the OPEX of certain technologies, however the exact amount required also depends among other things on characteristics of the digestate like buffer capacity. This makes an precise chemical cost estimation difficult.

The required **storage and housing space** for the NRR processes and products is again very case specific, product specific or technology cascade specific and cannot just be interpolated or extrapolated for a smaller or larger unit or amount of product produced.

**It can be concluded that the cost estimations made in this report are indications, which can be used to benchmark the costs against the respective costs for raw digestate disposal, when exploring the possibilities for NRR.**

It is important to note that comparing cost-efficiency of cascades alone cannot form the basis for decision making on the implementation of NRR technologies to treat digestate.

The total costs include other factors than weren't mentioned in this report, like the currently small but realistic market value for the obtained products, storage capacity of end products and reduction in digestate disposal.

In general, digestate processing with NRR cannot be regarded as a cheap and easy solution for most biogas plants. Yet, a specific technology cascade can prove cost-effective for a specific site, depending on the local boundary conditions and the market environment in which the plant is operating.

The design of technology cascade can also not be generalised and is frequently tailor-made for a specific biogas plant, to optimise the business case within its specific business environment. This is also time-dependent, meaning that external conditions, on which the business case was based, can change over time. When this happens, this could require a review of the business plan, including a possible reorganisation or redesign of the NRR technology to ensure the survival of the biogas plant.

**Currently, mainly operators of large-scale biogas plants that use supra-regional substrates benefit from treatment options for the digestate** (Fuchs and Drosig 2013). This is because they can balance the costs for digestate processing with the steadily rising costs for land application. Additionally, there is still some untapped revenue potential in the valorisation of the produced end products (see D 3.4 Market research in Europe). However, their market penetration is still in its infancy

It is therefore important to create a business case for digestate processing with NRR that is flexible towards future changes in business environment, market, subsidy schemes and legislation. This can be facilitated by maximally including (green) innovations and setting up cooperation and partnerships.

## 4 Expected impact

The using all the collected information in this report, a set of schemes with feasible technology cascades is selected and key techniques will be put forward as starting point for the discussions with the Outreach locations. This will contribute to the set-up of region-specific business cases and scenarios for ten selected EU Outreach Locations.

The 21 cascades (Annex I) are implemented in the NUTRICAS Tool, which is published as part of Business Development Package to support decision making for implementation of the innovative business cases in Europe.

This report and the BDP facilitate the transfer of knowledge and ongoing experiences from the demonstration plants to further outreach plants and identify opportunities for the uptake of the newly developed techniques into the business cases.

Table 4-1 CAPEX and OPEX of cascades DEMO plants .(Hermann and Hermann 2020a)

CAPEX= capital expenditures, NRR=nutrient recovery and reuse technology, M= million

	ACQUA E SOLE	AM-POWER	BENAS	GZV GENIUS + REPEAT	GENIUS	REPEAT	WATERLEAU
<b>CAPEX biogas plant (€)</b>		16.8M		16M			
<b>CAPEX NRR (€) <sup>1</sup></b>	22.5M	2.44M	20M	4M	3.5M	0.5M	11M
<b>OPEX (€) <sup>2</sup></b>							
Spare parts		24,959		992000			66,180
Consumables (chemicals)	17,202	375,326	17,604				333,825
Electricity					518,000	114,000	470
Use natural gas	850,000	1,445,000	398,400	108,000			47,964
Operations (Overhead, maintenance, repair)				306,000			850,328
Human resources (labour costs)	1,360,000	440,000	1,450,000	240,000	270,000	36,000	816,518
<b>Amortisation</b>	(15)	(12)	(12)	(12, 5)	(5)	(5)	(12)
	1,210,569	1,691,797	1,850,000	1560,000	600,000	60,000	470,000

<sup>1</sup> NRR: Aqua e Sole: enhanced N stripper-scrubber, AM-Power: 2x 3phase vacuum evaporator and RO, Benas: FiberPlus system, GZV: GENIUS and RePeat systems, Waterleau New Energy: Evaporator and 2 RO's

More detailed information and technology cascades can be found in the D 2.2 Business Case Evaluation Report and Demo Plant Fact sheets.

<sup>2</sup> OPEX based on yearly operational cost for the year 2020 (AM-Power), 2019 ( Waterleau New Energy, GZV and Acqua e Sole) and 2018 (Benas)

## I. Annex I

The cascades available in the NUTRICAS Tool are presented below. It is a non-exhaustive list that can be updated in the remaining timeframe of the project. These cascades are based on process schemes of operational full scale biogas plants or are based on these existing cascades but include a variation in the separation steps. Some existing biogas plants even combine multiple cascades.

**1**

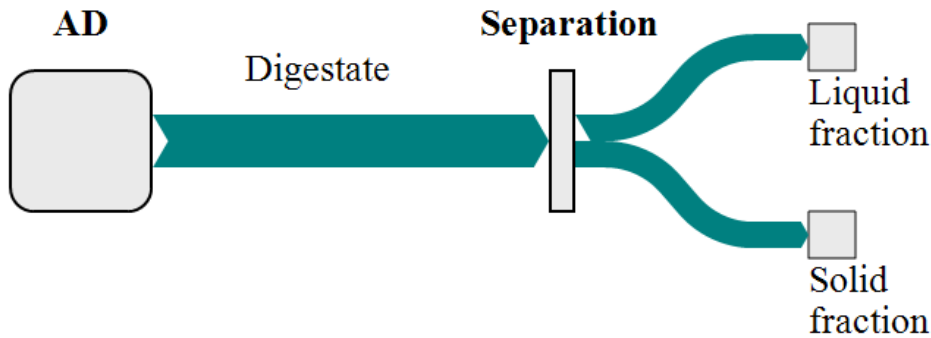

Figure I-2 Cascade 1

SCRL Kessler are separating a part of their digestate with a screw press. Stormossen Ab/Oy(Fi) and AFBI (UK) are using a centrifuge.

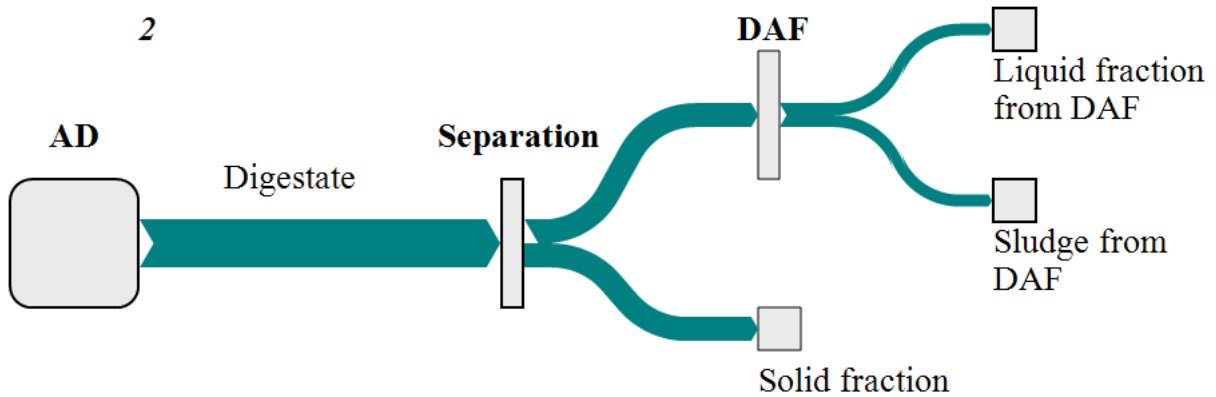

Figure I-1 Cascade 2

Demo Plant AM-Power used a DAF in their original digestate treatment process and Demo Plant Groot Zevert is still using it.

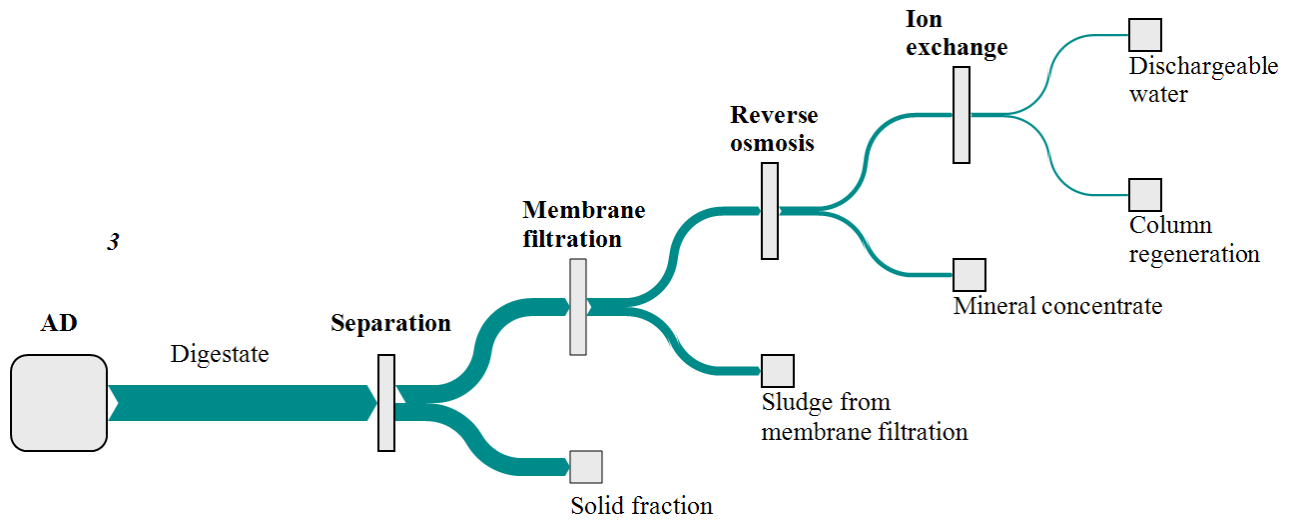

Figure I-3 Cascade 3

Associated Plant Arbio BVBA (BE) uses a belt press as separator in this process. They don't have an ion exchanger, so they don't produce dischargeable water but irrigation water.

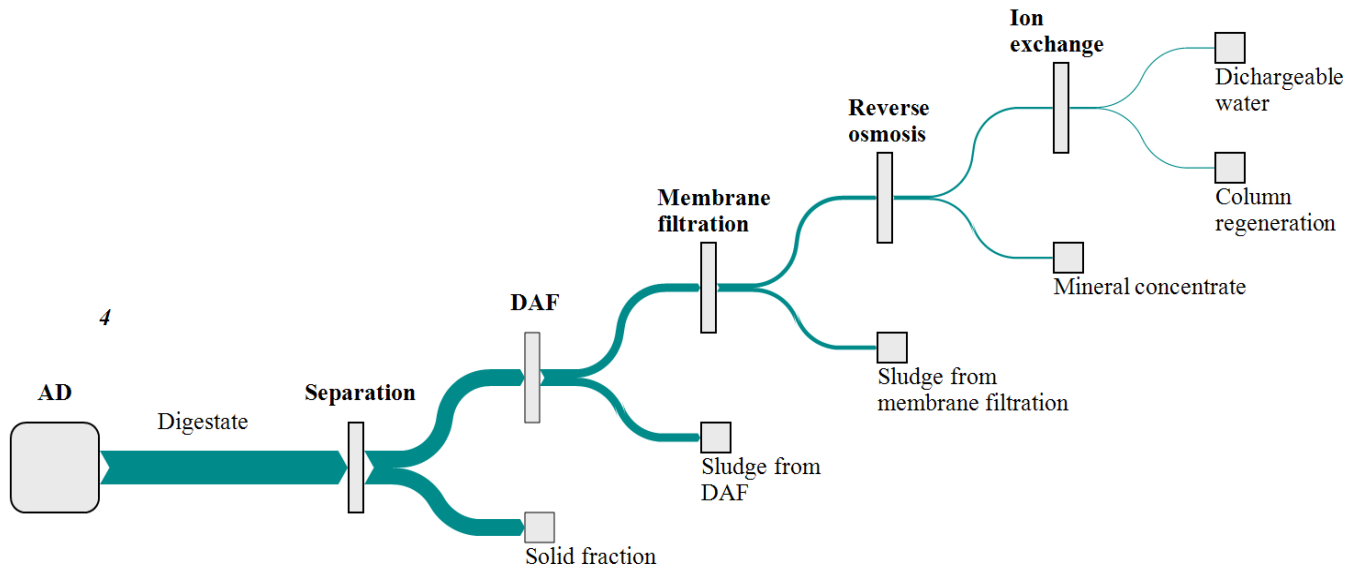

Figure I-4 Cascade 4

Demo Plant Groot Zevert Vergisting (NL) combines this cascade with Cascade 18.



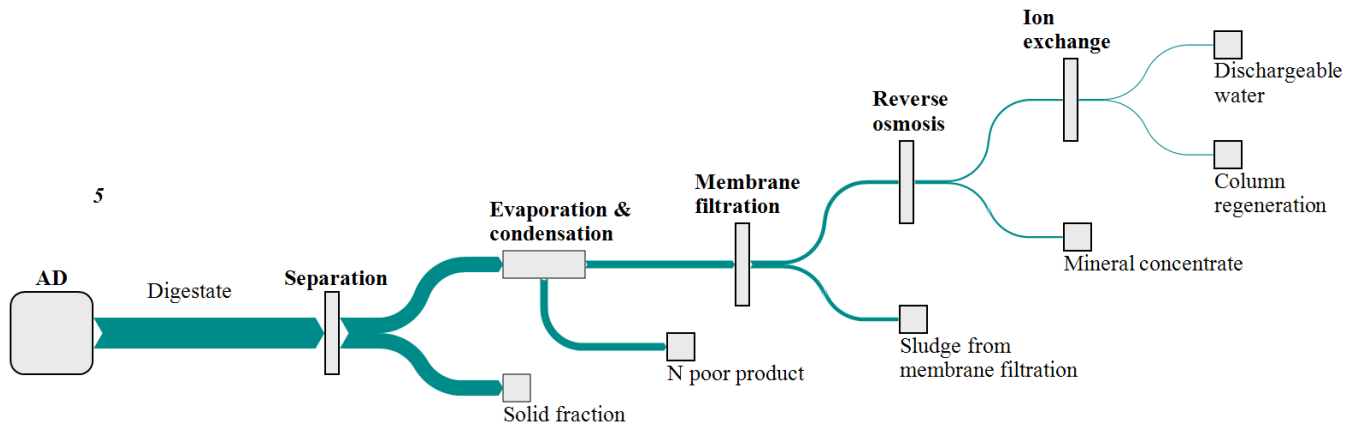

Figure I-5 Cascade 5

Demo Plant AM-Power (BE) and Outreach Location Atria (FI) use this cascade without the membrane filtration and ion exchanger to produce dischargeable water. They acidify the input of the evaporator to keep the nitrogen concentrate of the evaporator product. (The N poor product becomes N rich product).

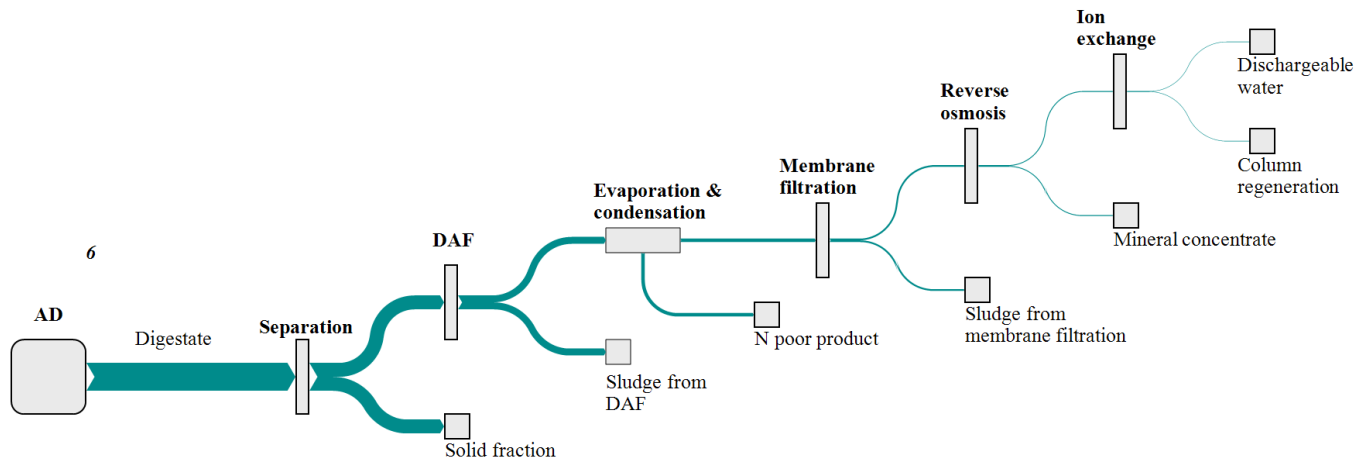

Figure I-6 Cascade 6

This cascade is a variation on Cascade 5.

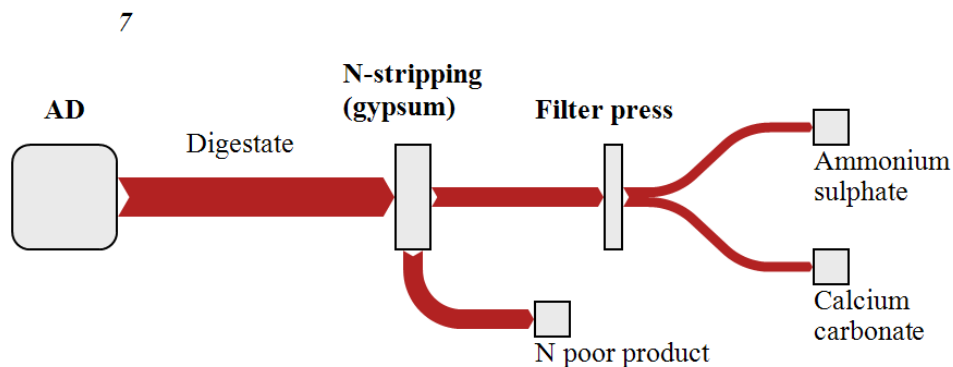

Figure I-7 Cascade 7

Demo Plant Benas (DE) uses this N-stripping-scrubbing technique.

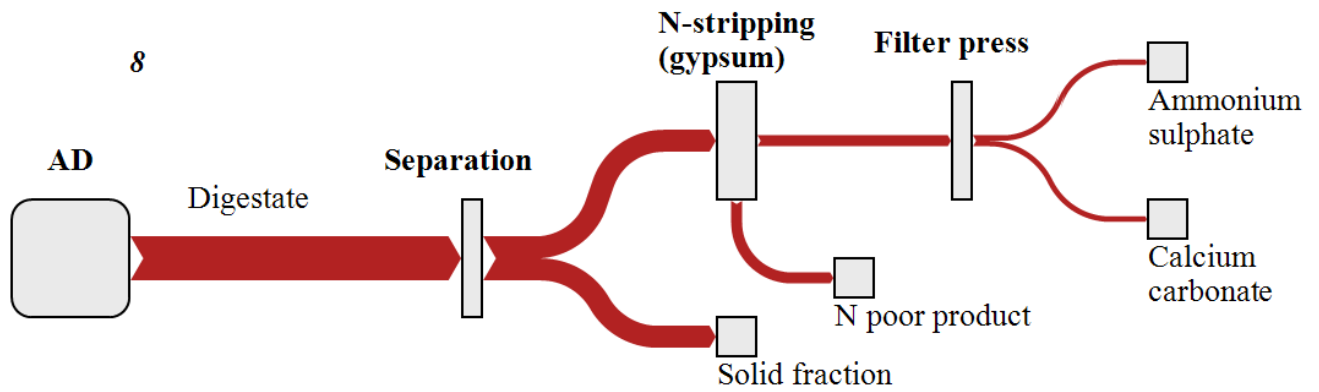

Figure I-8 Cascade 8

This cascade is a variation on Cascade 7.

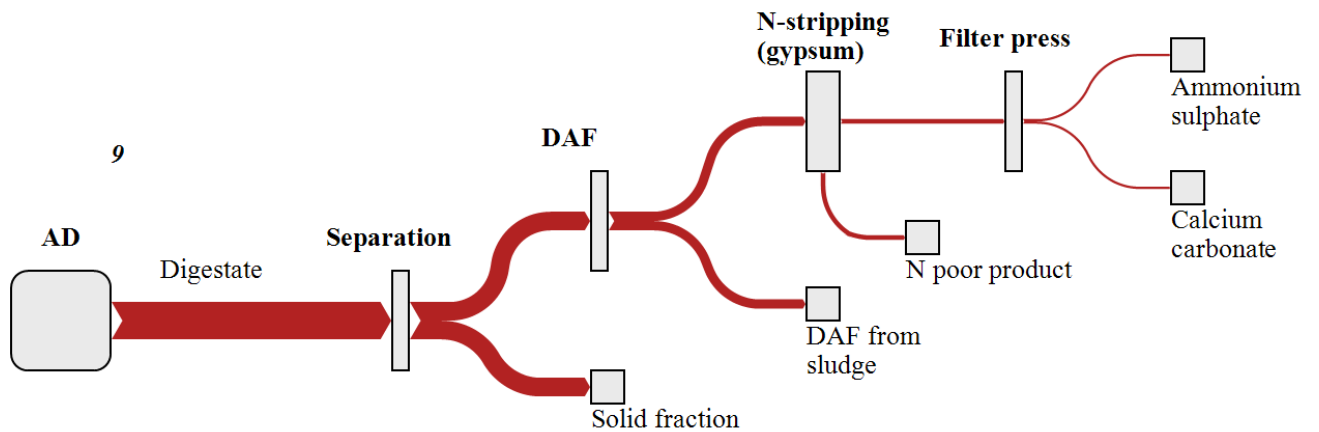

Figure I-9 Cascade 9

This cascade is a variation on Cascade 7.

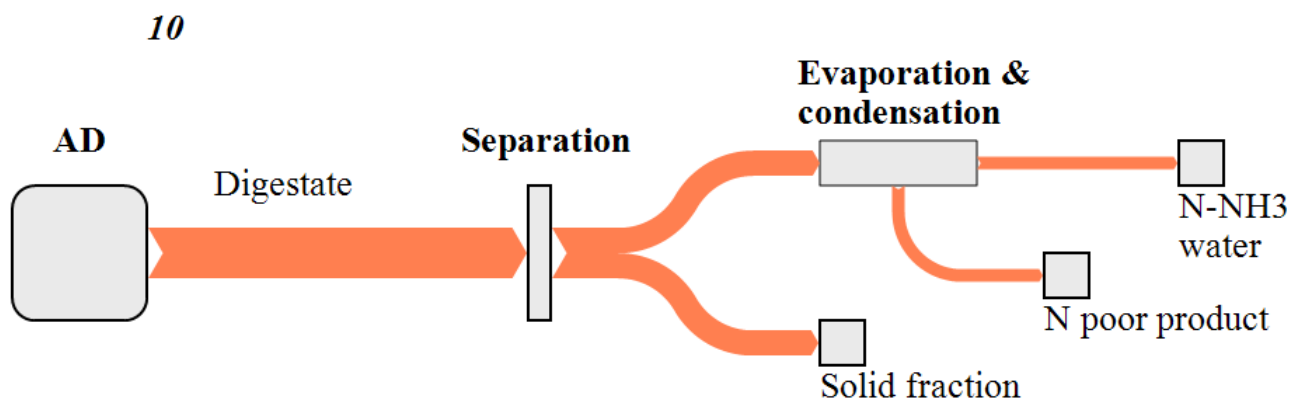

Figure I-10 Cascade 10

Associated Plants Storg (BE) and Group op de Beeck (BE) use this cascade with respectively a belt press and a centrifuge as separation technique.

Outreach Location Waterleau New Energy (BE) and Associated Plant IVVO(BE) use this cascade with biological nitrification-denitrification as pre-treatment for the evaporation.

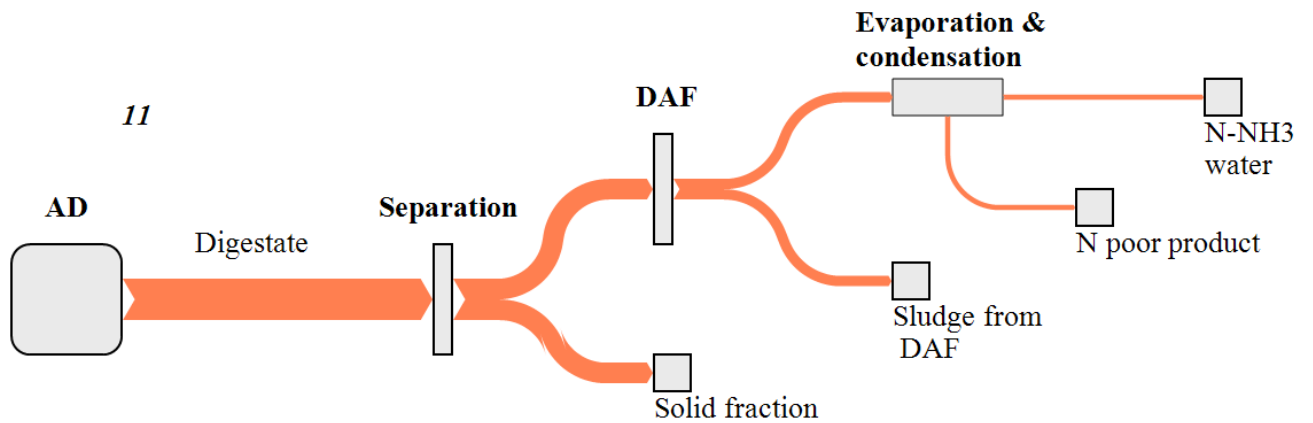

Figure I-11 Cascade 11

This cascade is a variation on Cascade 10.

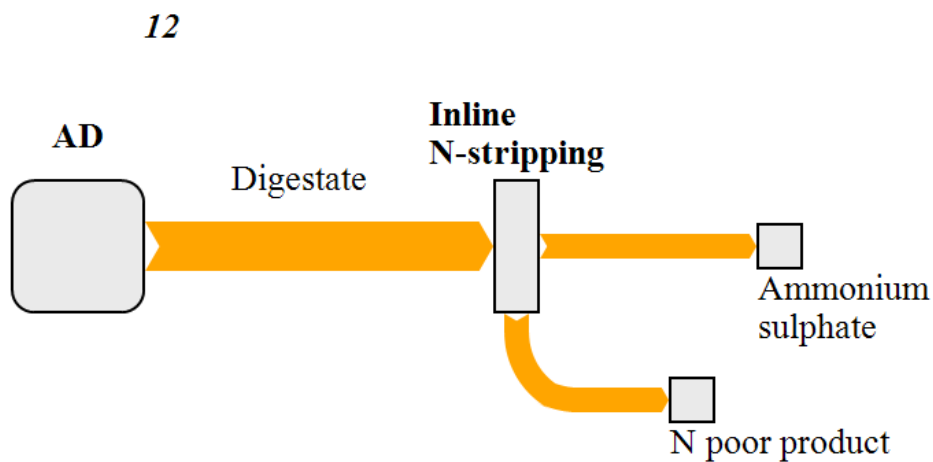

Figure I-13 Cascade 12

Acqua e Sole (IT) and Greencreate W2V Ltd Kent (UK) have inline strippers to produce a N poor product.

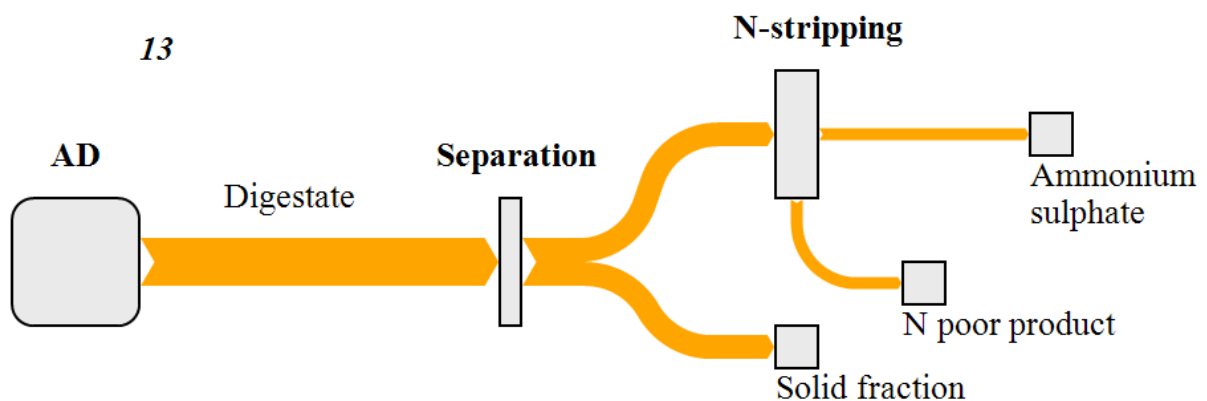

Figure I-12 Cascade 13

Outreach Location Emeraude Bioenergie (FR) and Associated Plants Greenlogix BioEnergy (BE), NDM (DE) are doing ammonia stripping-scrubbing on the liquid fraction of their digestate.

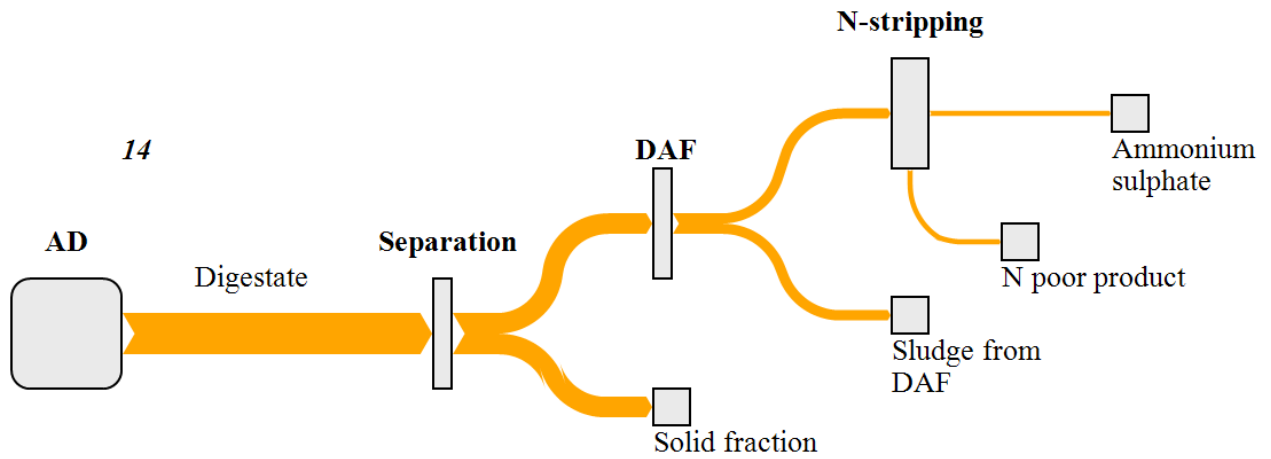

Figure I-14 Cascade 14

This cascade is a variation on Cascade 13.

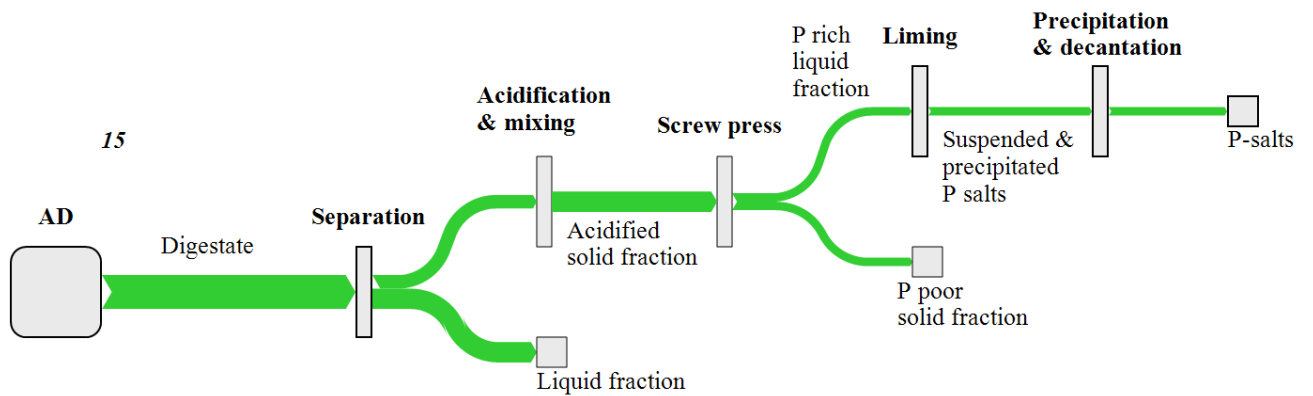

Figure I-15 Cascade 15

This cascade is a variation on Cascade 18, which is currently operational at a biogas plant.

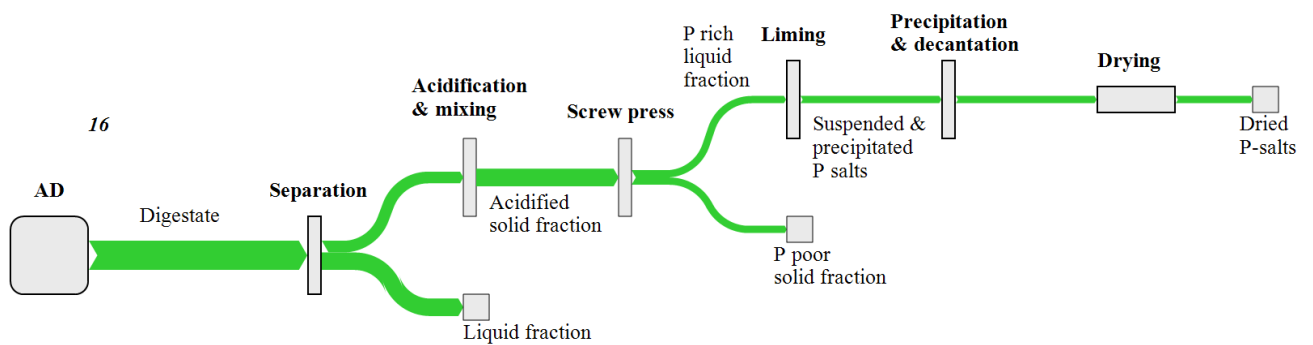

Figure I-16 Cascade 16

This cascade is a variation on Cascade 18, which is currently operational at a biogas plant.

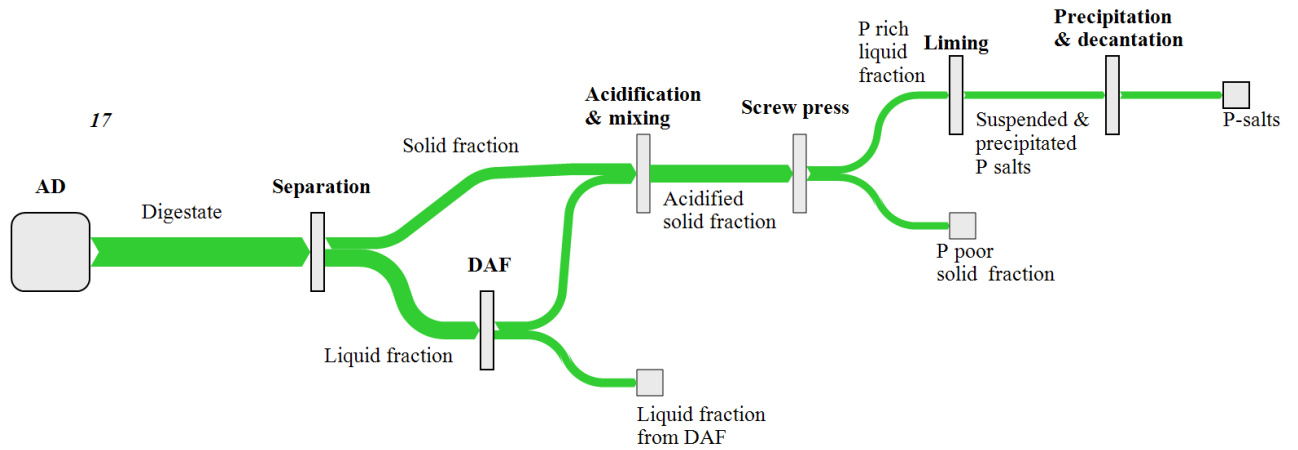

Figure I-19 Cascade 17

This cascade is a variation on Cascade 18, which is currently operational at a biogas plant.

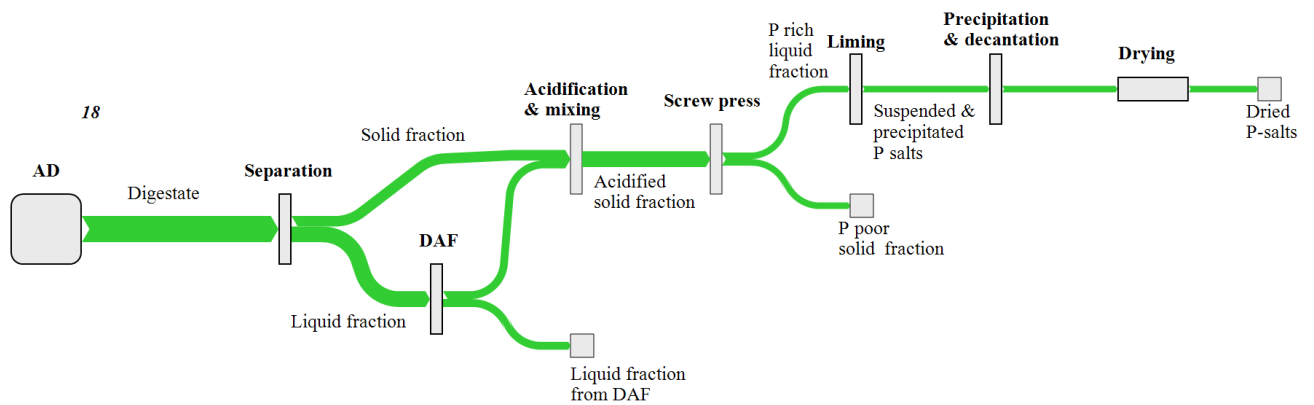

Figure I-18 Cascade 18

This cascade is operational at Demo Plant Groot Zevent Vergisting, where it is combined with Cascade 4.

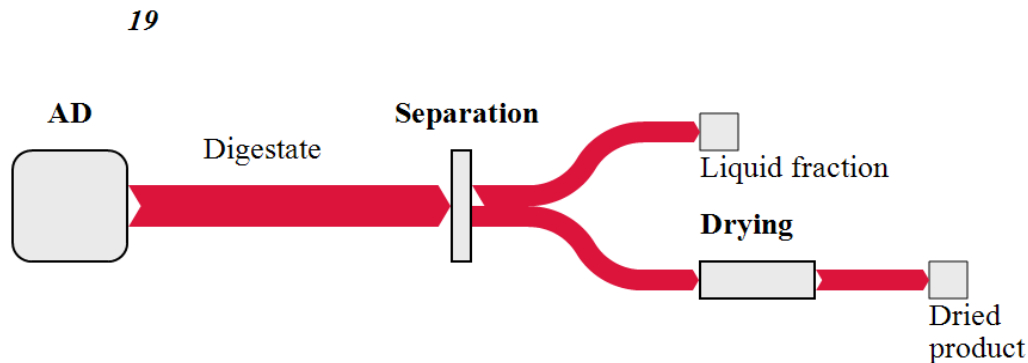

Figure I-17 Cascade 19

Outreach Location Waterleau New Energy(BE) is drying the solid fraction after centrifugation in a Hydrogone® dryer.

Outreach Locations Biogas Bree (BE) is drying the solid fraction of the digestate after centrifuge with an in-house developed drying system combined with acid air scrubbing of the exhaust air.

Associated Plant Arbio (BVBA) is drying the solid fraction of the digestate mixed with N-rich concentrate from the membrane filtration.

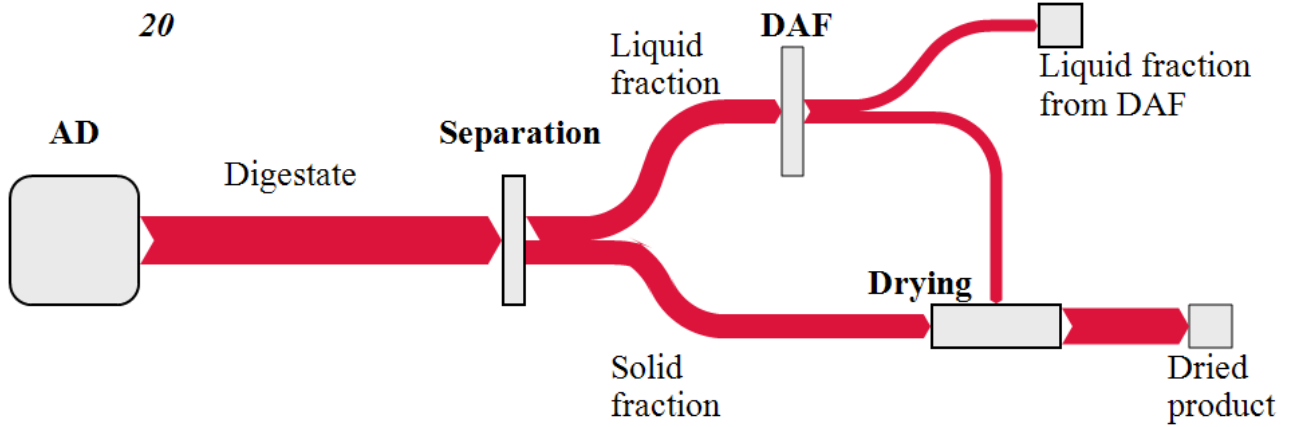

Figure I-20 Cascade 20

This cascade describes a part the old process at Demo Plant AM-Power. It was combined with Cascade 3, without the membrane filtration and ion exchanger.

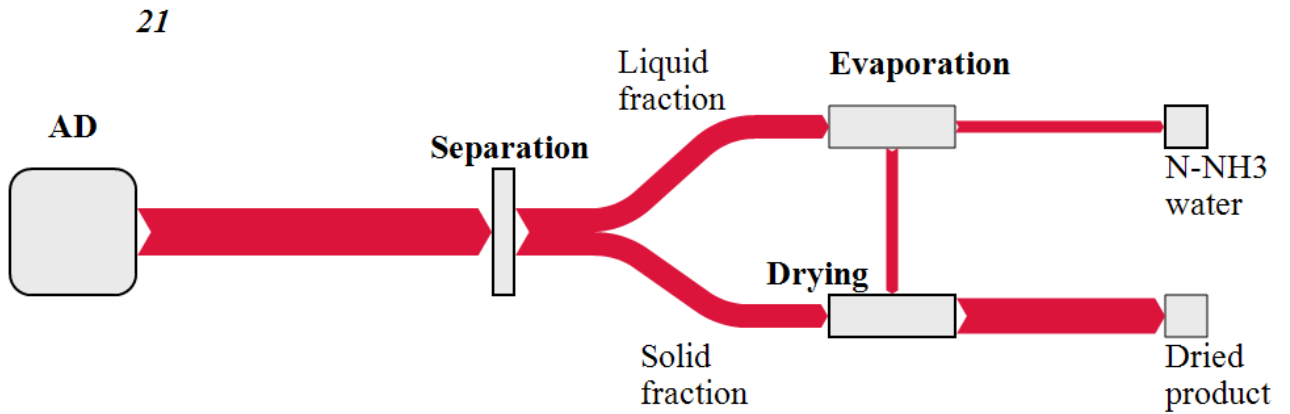

Figure I-21 Cascade 21

Demo Plant AM-Power (BE) is currently drying the concentrate after evaporation in a fluidized bed dryer together with the solid fraction after centrifuge. This cascade is combined with Cascade 5.

## References

- Agro Business Park. 2011. *Manure Processing Technologies*.
- Bamelis, Lies. 2016. *Digestaat Op Maat: Inventarisatie Beschikbare Technieken*.  
<http://www.vlaco.be/sites/default/files/generated/files/page/zo-16101800001-rap-lba-10-11-2016.pdf>  
(June 25, 2018).
- Barampouti, E. M. et al. 2020. "Exploring Technological Alternatives of Nutrient Recovery from Digestate as a Secondary Resource." *Renewable and Sustainable Energy Reviews* 134: 1–2.
- Battistoni, P. et al. 2002. "P Removal from Anaerobic Supernatants by Struvite Crystallization: Long Term Validation and Process Modelling." *Water Research*.
- Battistoni, P., R. Boccadoro, F. Fatone, and P. Pavan. 2005. "Auto-Nucleation and Crystal Growth of Struvite in a Demonstrative Fluidized Bed Reactor (FBR)." *Environmental Technology*.
- Bauer, Alexander, Herwig Mayr, Katharina Hopfner-Sixt, and Thomas Amon. 2009. "Detailed Monitoring of Two Biogas Plants and Mechanical Solid-Liquid Separation of Fermentation Residues." *Journal of Biotechnology*.
- Bilstad, T., M. Madland, E. Espedal, and P. H. Hanssen. 1992. "Membrane Separation of Raw and Anaerobically Digested Pig Manure." In *Water Science and Technology*.
- Block, R. 2009. Fachagentur Nachwachsende Rohstoffe e.V. (Ed.), Garrestaufbereitung für eine pflanzenbauliche Nutzung e Stand und FpE-Bedarf *Ökonomische Und Ökologische Bewertung von Garrestaufbereitungssystemen - Auf Der Basis von Praxisversuchen*. Gülzow.
- Bolzonella, D., F. Fatone, M. Gottardo, and N. Frison. 2017. "Nutrients Recovery from Anaerobic Digestate of Agro-Waste: Techno-Economic Assessment of Full Scale Applications."  
<http://dx.doi.org/10.1016/j.jenvman.2017.08.026> (March 7, 2018).
- Bonmatí, August, and Xavier Flotats. 2002. "Air Stripping of Ammonia from Pig Slurry: Characterisation and Feasibility as a Pre-or Post-Treatment to Mesophilic Anaerobic Digestion." *Waste management* 23.  
[www.elsevier.com/locate/wasman](http://www.elsevier.com/locate/wasman) (August 9, 2018).
- . 2012. "Pig Slurry Concentration by Vacuum Evaporation: Influence of Previous Mesophilic Anaerobic Digestion Process." *Journal of the Air & Waste Management Association* 53(1): 21–31.  
<http://www.tandfonline.com/loi/uawm20> (August 9, 2018).
- Bousek, J et al. 2016. "Influence of the Gas Composition on the Efficiency of Ammonia Stripping of Biogas Digestate." *Bioresource Technology* 203: 259–66.
- Brienza, Claudio et al. 2018. *SYSTEMIC D 1.2 First Annual Updated Report on Mass and Energy Balances, Product Composition and Quality and Overall Technical Performance of the Demonstration Plants (Year 1)*.
- . 2019. *SYSTEMIC D 1.3 Second Annual Updated Report on Mass and Energy Balances, Product Composition and Quality and Overall Technical Performance of the Demonstration Plants (Year 2)*.
- . 2020. *5 SYSTEMIC D 1.4 Third Annual Updated Report on Mass and Energy Balances, Product Composition and Quality and Overall Technical Performance of the Demonstration Plants (Year 3)*.
- Buckwell, A et al. 2014. *Sustainable Intensification of European Agriculture*.
- Camargo-Valero, M.A. et al. 2015. *Techniques for Nutrient Recovery from Manure and Slurry*. BIOREFINE Recycling inorganic chemicals from agro-and bio-industrial waste streams.
- Campos, Alejandra, and Jennifer Bilbao. 2015. *Recovery of Phosphorus from Manure and Digestate in the Framework of the European EU-Interreg IVB-NWE-ARBOR Project*.
- Ceulemans, Johan, and Wim Schiettecatte. 2013. *MIP Nutriecycle WP2 Inventarisatie van Bestaande Technieken Voor Nutriënt Recuperatie Uit Digestaat En Mest*.
- Charlebois, Y. 2000. "Du Lisier Changé En Eau Potable." *La Terre de Chez Nous* 71: 1–2.
- Chiumenti, A et al. 2013. "Treatment of Digestate from a Co-Digestion Biogas Plant by Means of Vacuum Evaporation: Tests for Process Optimization and Environmental Sustainability." *Waste Management* 33: 1339–44. <http://dx.doi.org/10.1016/j.wasman.2013.02.023> (August 9, 2018).
- Cocolo, G. 2012. "Assesment of Different Solid-Liquid Separation Techniques for Livestock Slurry." UNIVERSITÀ DEGLI STUDI DI MILANO.  
[https://air.unimi.it/retrieve/handle/2434/232584/301449/phd\\_unimi\\_R09277.pdf](https://air.unimi.it/retrieve/handle/2434/232584/301449/phd_unimi_R09277.pdf) (August 4, 2017).
- Collivignarelli, Carlo, Giorgio Bertanza, Marco Baldi, and Franco Avezù. 1998. "Ammonia Stripping from MSW Landfill Leachate in Bubble Reactors: Process Modeling and Optimization." *Waste Management and Research*.
- de Dardel, François. 2021. "Ion Exchange Basics." [http://dardel.info/IX/IX\\_Intro.html](http://dardel.info/IX/IX_Intro.html).
- Derden, An, and Roger Dijkmans. 2020. *Addendum Bij de Studie " Beste Beschikbare Technieken ( BBT ) Voor Mestverwerking - Derde Uitgave " Mestverwerkingstrajecten : BBT En " Technieken in Opkomst " Met Focus Op Nutriëntrecuperatie Eindrapport An Derden En Roger Dijkmans*. [www.emis.vito.be](http://www.emis.vito.be) (January 13, 2021).

- Desmidt, Evelyn et al. 2015. "Global Phosphorus Scarcity and Full-Scale P-Recovery Techniques: A Review." *Critical Reviews in Environmental Science and Technology*.
- Digesmart. 2016. *D3.4 Report on the Analysis, Regulations and Field Performance of the Mineral Fertilisers Produced*. [http://digesmart.eu/documentos/D3.4 Report on the analysis regulations and field performance of the mineral fertilizers produced \(public\)\\_EN.pdf](http://digesmart.eu/documentos/D3.4%20Report%20on%20the%20analysis%20regulations%20and%20field%20performance%20of%20the%20mineral%20fertilizers%20produced%20(public)_EN.pdf) (January 2, 2018).
- Dijkstra, T et al. 2012. *Integratie van Biogasproductie En Winning van Kunstmestvervangers Uit Dierlijke Mest*. [http://www.kennisakker.nl/files/Kennisdocument/Rapport\\_geintegreerde\\_biogasproductie\\_en\\_winning\\_van\\_kunstmestvervangers\\_uit\\_dierlijke\\_mest.pdf](http://www.kennisakker.nl/files/Kennisdocument/Rapport_geintegreerde_biogasproductie_en_winning_van_kunstmestvervangers_uit_dierlijke_mest.pdf) (September 1, 2017).
- Döhler, H., and S. Wulf. 2009. "Aktueller Stand Bei Der Gärrestaufbereitung." *Facha- gentur Nachwachsende Rohstoffe e.V.* (Gärrestaufbereitung für eine pflanzenbauliche Nutzung e Stand und FpE-Bedarf): 15–28.
- Doyle, J. D., K. Oldring, J. Churchley, and S. A. Parsons. 2002. "Struvite Formation and the Fouling Propensity of Different Materials." *Water Research*.
- Drosg, Bernhard et al. 2015. *IEA Bioenergy Nutrient Recovery by Biogas Digestate Processing*. [http://www.iea-biogas.net/files/daten-redaktion/download/Technical Brochures/NUTRIENT\\_RECOVERY\\_RZ\\_web1.pdf](http://www.iea-biogas.net/files/daten-redaktion/download/Technical%20Brochures/NUTRIENT_RECOVERY_RZ_web1.pdf) [http://www.iea-biogas.net/files/daten-redaktion/download/Technical Brochures/NUTRIENT\\_RECOVERY\\_RZ\\_web2.pdf](http://www.iea-biogas.net/files/daten-redaktion/download/Technical%20Brochures/NUTRIENT_RECOVERY_RZ_web2.pdf).
- EC-JRC. 2017. *BREF Intensive Rearing of Poultry or Pigs*. [https://eippcb.jrc.ec.europa.eu/reference/BREF/IRPP/JRC107189\\_IRPP\\_Bref\\_2017\\_published.pdf](https://eippcb.jrc.ec.europa.eu/reference/BREF/IRPP/JRC107189_IRPP_Bref_2017_published.pdf).
- Ehmann, Andrea et al. 2019. "Phosphates Recycled from Semi-Liquid Manure and Digestate Are Suitable Alternative Fertilizers for Ornamentals." *Scientia Horticulturae*.
- EIP-AGRI Focus Group. 2017. *EIP-AGRI Focus Group-Nutrient recycling Nutrient Recycling - Final Report*.
- Emerson, Kenneth, Rosemarie C. Russo, Richard E. Lund, and Robert V. Thurston. 1975. "Aqueous Ammonia Equilibrium Calculations: Effect of PH and Temperature." *Journal of the Fisheries Research Board of Canada*.
- EPCON. 2015. "Brochure: Biogas Digestate Treatment by MVR Evaporation." [http://www.epcon.org/uploads/4/6/3/5/46351051/epcon\\_biogas\\_brochure\\_rev\\_300.pdf](http://www.epcon.org/uploads/4/6/3/5/46351051/epcon_biogas_brochure_rev_300.pdf) (August 9, 2018).
- Errico, Massimiliano, Lene Fjerbaek Sotoft, Anne Kjærhuus Nielsen, and Birgir Norddahl. 2018. "Treatment Costs of Ammonia Recovery from Biogas Digestate by Air Stripping Analyzed by Process Simulation." *Clean Technologies and Environmental Policy* 20(7): 1479–89. <https://doi.org/10.1007/s10098-017-1468-0>.
- Evers, A.G., M.H.A. de Haan, F.E. de Buissonjé, and K. Verloop. 2010. *Perspectief Mestscheiding Op Melkveebedrijven, Rapport 421*. Wageningen. <http://edepot.wur.nl/160177> (August 2, 2017).
- Ewert, W et al. 2014. Sustainable sewage sludge management fostering phosphorus recovery and energy efficiency *Deliverable 5.1 Description of Sludge Related Processes*.
- Fangueiro, D et al. 2011. *Mini- Paper – Available Technologies for Nutrients Recovery from Animal Manure and Digestates*.
- Fangueiro, David et al. 2017. "Mini-Paper-Available Technologies for Nutrients Recovery from Animal Manure and Digestates." *EIP-AGRI Focus Group-Nutrient recycling*. [www.phosphorusplatform.eu](http://www.phosphorusplatform.eu) (August 3, 2020).
- FH Münster, and Kalk. 2021. "Presentation: Project L'AmmoRE." In *Progress in Manure & Digestate*, ed. IBBK.
- Fluence. 2021. "What Is Ion Exchange?" <https://www.fluencecorp.com/what-is-ion-exchange/>.
- Fraunhofer IGB. 2021. "BioEcoSIM® – Combined Process for the Treatment of Liquid Manure and Fermentation Residues." <https://www.igb.fraunhofer.de/en/research/water-technologies/nutrient-recovery/bioecosim-combined-process-for-treatment-of-manure-and-digestate.html>.
- Fuchs, W, and B Drosg. 2013. "Assessment of the State of the Art of Technologies for the Processing of Digestate Residue from Anaerobic Digesters." <http://cyber.sci-hub.tw/MTAuMjE2Ni93c3QuMjAxMy4wNzU=/10.2166%40wst.2013.075.pdf> (June 7, 2018).
- Gerardo, Michael L., Nasser H M Aljohani, Darren L. Oatley-Radcliffe, and Robert W. Lovitt. 2015. "Moving towards Sustainable Resources: Recovery and Fractionation of Nutrients from Dairy Manure Digestate Using Membranes." *Water Research* 80.
- Ghyselbrecht, K. et al. 2017. "The Fate of Nitrite and Nitrate during Anaerobic Digestion." *Environmental Technology*.
- Gienau, T, · U Brüß, · M Kraume, and · S Rosenberger. 2018a. "Nutrient Recovery from Anaerobic Sludge by Membrane Filtration: Pilot Tests at a 2.5 MWe Biogas Plant." *International Journal of Recycling of Organic Waste in Agriculture* 7: 325–34. <https://doi.org/10.1007/s40093-018-0218-6> (January 4, 2019).
- Gienau, T, U Brüß, M Kraume, and S Rosenberger. 2018b. "Nutrient Recovery from Biogas Digestate by Optimised Membrane Treatment." *Waste and Biomass Valorization* 1: 3. <https://doi.org/10.1007/s12649-018-0231-z> (January 4, 2019).
- Gienau, Tobias, Matthias Kraume, and Sandra Rosenberger. 2018. "Rheological Characterization of Anaerobic



- Sludge from Agricultural and Bio-Waste Biogas Plants." *Chemie INgenieur Technik* 90(7). www.cit-journal.com (January 4, 2019).
- Gorissen, Annelies, and Emilie Snauwaert. 2018. *Oplossingen Voor Het Mestoverschot in de Melkveehouderij*. Bruges. www.vcm-mestverwerking.be (January 18, 2019).
- Gregory, J. 1989. *Fundamentals of Flocculation*. 19th ed. Crit. Rev. Env. Cont.
- Gruwez, Jan. 2012. *Wegwijs in de Industriële Afvalwaterzuivering*. ed. Hans Suijkerbuijk. Wolters Kluwer Belgium.
- Guilayn, F. et al. 2019. "Digestate Mechanical Separation: Efficiency Profiles Based on Anaerobic Digestion Feedstock and Equipment Choice." *Bioresource Technology* 274(September 2018): 180–89.
- Guo, Jin Song et al. 2010. "Treatment of Landfill Leachate Using a Combined Stripping, Fenton, SBR, and Coagulation Process." *Journal of Hazardous Materials*.
- Guštin, Simon, and Romana Marinšek-Logar. 2011. "Effect of PH, Temperature and Air Flow Rate on the Continuous Ammonia Stripping of the Anaerobic Digestion Effluent." *Process Safety and Environmental Protection* 89(1): 61–66. <http://linkinghub.elsevier.com/retrieve/pii/S0957582010001102> (December 18, 2017).
- Hallbar Consulting. *Evaluation of Nutrient Recovery Technologies for Dairy Manure and Digestate*.
- Herbes, Carsten, Ursula Roth, Sebastian Wulf, and Johannes Dahlin. 2020. "Economic Assessment of Different Biogas Digestate Processing Technologies: A Scenario-Based Analysis." *Journal of Cleaner Production* 255: 120282. <https://doi.org/10.1016/j.jclepro.2020.120282>.
- Hermann, Ludwig, and Ralf Hermann. 2020a. *SYSTEMIC D 2.2 Business Case Evaluation Report*.  
 ———. 2020b. *SYSTEMIC D2.4 Final Report on the Development and Application of Economic Key Performance Indicators (KPIs)*.
- Heviánková, S, R Souček, M Kynl, and N Surovcová. 2015. "Contribution to the Study of Flocculation of Digestate." *GeoScience Engineering* LXI(3): 37–44.
- Hjorth, M., K. V. Christensen, M. L. Christensen, and S. G. Sommer. 2010. "Solid-Liquid Separation of Animal Slurry in Theory and Practice. A Review." *Agronomy for Sustainable Development* 30(1): 153–80.
- Hoeksma, P., and F.E. De Buissonjé. 2011. *Mineralenconcentraten Uit Dierlijke Mest*. Wageningen.
- Hoeksma, P., F.E. de Buissonjé, and A.J.A. Aarnink. 2012. "Full-Scale Production of Mineral Concentrates from Pig Slurry Using Reverse Osmosis." In *9th International Livestock Environment Symposium, Valencia, Spain*: ASABE, 6.
- de Hoop, JG, CHG Daatselaar, GJ Doornewaard, and NC Tomson. 2011. *Mineralenconcentraten Uit Mest; Economische Analyse En Gebruikerservaringen Uit de Pilots Mestverwerking in 2009 En 2010*. <http://edepot.wur.nl/177108> (March 26, 2019).
- Hou, Yong. 2016. "Towards Improving the Manure Management Chain." Wageningen University. <http://library.wur.nl/WebQuery/wurpubs/fulltext/392808> (September 14, 2018).
- Huybrechts, D., and R Dijkmans. 2001. *Beschikbare Technieken Voor de Verwerking van RWZI- En Gelijkaardig Industrieel Afvalwaterzuiveringsslib*.
- Keysers, Tim. 2006. "Vergisting Met Nabehandeling van Digestaat."
- Krakat, Niclas et al. 2017. "Methods of Ammonia Removal in Anaerobic Digestion: A Review." *Water Science and Technology* 76(8): 1925–38. <http://wst.iwaponline.com/lookup/doi/10.2166/wst.2017.406> (January 10, 2018).
- Kühne, Stephan. 2018. "Next-Generation Digestate Treatment: Agrifer, Biogastechnik." In *IBBK: Progress in Manure and Digestate Technology*.
- Kuiper, P, D Vroon, G Rijs, and S Plette. 2006. *Mestverwerking En Mogelijke Emissies Naar Oppervlaktewater*. <http://www.vcm-mestverwerking.be/publicationfiles/RWSRIZA2006031.pdf> (January 4, 2018).
- Laureni, Michele, Jordi Palatsi, Montserrat Llovera, and August Bonmatí. 2013. "Influence of Pig Slurry Characteristics on Ammonia Stripping Efficiencies and Quality of the Recovered Ammonium-Sulfate Solution." *Journal of Chemical Technology & Biotechnology* 88(9): 1654–62. <http://doi.wiley.com/10.1002/jctb.4016> (March 14, 2018).
- Law, Chung Lim, and Arun S Mujumdar. 2015. *8 Fluidized Bed Dryers*. <http://cyber.sci-hub.tw/MTAuMTIwMS9iMTcyMDgtMTE=/10.1201%40b17208-11.pdf> (October 5, 2018).
- Lebuf, V. et al. 2013. "Inventory: Techniques for Nutrient Recovery from Digestate."
- Lemmens, B et al. 2020. *Beste Beschikbare Technieken (BBT) Voor Mestverwerking (Derde Uitgave)*. <http://www.emis.vito.be> (January 13, 2021).
- Limoli, Alice, Michela Langone, and Gianni Andreottola. 2016. "Ammonia Removal from Raw Manure Digestate by Means of a Turbulent Mixing Stripping Process." *Journal of Environmental Management* 176: 1–10. <http://moscow.sci-hub.tw/2fcc2e2ce282c20cff4ee08dfd665a8e/10.1016%40j.jenvman.2016.03.007.pdf> (May 22, 2018).
- Liu, Liang, Changle Pang, Shubiao Wu, and Renjie Dong. 2015. "Optimization and Evaluation of an Air-Recirculated Stripping for Ammonia Removal from the Anaerobic Digestate of Pig Manure." *Process Safety*

- and *Environmental Protection* 94: 350–57.  
<http://linkinghub.elsevier.com/retrieve/pii/S095758201400127X> (January 10, 2018).
- Magrí, Albert. 2018. "Research Trends on Nutrient Management From Digestates Assessed Using a Bibliometric Approach." *Frontiers in Sustainable Food Systems*.
- Manyi-Loh, C.E. Mamphweli, S.N., and E.L. Meyer. 2019. "Microbial Anaerobic Digestion: Process Dynamics and Implications from the Renewable Energy, Environmental and Agronomy Perspectives." *International Journal of Environmental Science and Technology* volume 16: 3913–34.
- Masse, L., D.I. Massé, V. Beaudette, and M. Muir. 2005. "Size Distribution and Composition of Particles in Raw and Anaerobically Digested Swine Manure." *American Society of Agricultural and Biological Engineers* 48(5): 1943–49.
- Melse, R., F.E. De Buissonjé, N. Verdoes, and H.C. Willers. 2004. "Quick Scan van Be- En Verwerkingstechnieken Voor Dierlijke Mest." (November): 1–55. <http://docplayer.nl/10164254-Rapportage-opdrachtgever-1390938000-quick-scan-van-be-en-verwerkingstechnieken-voor-dierlijke-mest.html> (August 3, 2017).
- Melse, R W.J., Starmans D.A.J., and N. Verdoes. 2002. *Mestverwerking Varkenshouderij - Mestscheiding En Microfiltratie, Dirven Te Someren*. <http://www.pv.wageningen-ur.nl> (June 25, 2018).
- Menkveld, H. W. H., and E. Broeders. 2017. "Recovery of Ammonium from Digestate as Fertilizer." *Water Practice and Technology* 12(3): 514–19. <http://wpt.iwaponline.com/lookup/doi/10.2166/wpt.2017.049> (March 7, 2018).
- Møller, H.B., S.G. Sommer, and B.K. Ahring. 2002. "Separation Efficiency and Particle Size Distribution in Relation to Manure Type and Storage Conditions." *Bioresource Technology* 85(2): 189–96.  
<http://linkinghub.elsevier.com/retrieve/pii/S0960852402000470> (July 26, 2017).
- Monfet, Evelyne, Geneviève Aubry, and Antonio Avalos Ramirez. 2018. "Nutrient Removal and Recovery from Digestate: A Review of the Technology." *Biofuels* 9(2): 247–62.  
<http://dx.doi.org/10.1080/17597269.2017.1336348>.
- Muys, Maarten et al. 2021. "A Systematic Comparison of Commercially Produced Struvite: Quantities, Qualities and Soil-Maize Phosphorus Availability." *Science of the Total Environment* 756: 143726.  
<https://doi.org/10.1016/j.scitotenv.2020.143726>.
- Mykkänen, Eeli, and Teija Paavola. 2016. *Jätevesityypen Talteenotto Ja Hyödyntäminen Kierrätysravinteena KiertoTyppi -Hanke Loppuraportti*.
- Nakazi, S. et al. 2009. "Wärmenutzungskonzepte Für Biogasanlagen." *Landtechnik*: 326–29.
- Novem. 1998. "Energie-Efficiënt Drogen En Verwerken van Slib En Mest." *Mint studie*.
- Postma, R et al. 2012. *Inventarisatie, Toepasbaarheid En Klimaat-effecten van Producten van Mest*.  
 ——. 2013. "Producten van Mest: Toepasbaarheid En Klimaat-effecten | Kennisakker.NL." *NMI, Alterra en BLGG Research* (088). <http://www.kennisakker.nl/node/3770>.
- Prodănescu, Alexandra. 2017. "Dewaterability of Thermophilic Digestate : Characteristics and Underlying Processes." (November).
- Regelink, Inge et al. 2019. *Phosphorus Recovery from Co-Digested Pig Slurry Development of the RePeat Process*. [www.wur.eu/environmental-research](http://www.wur.eu/environmental-research) (January 14, 2020).
- Rehl, T., and J. Müller. 2011. "Life Cycle Assessment of Biogas Digestate Processing Technologies." *Resources, Conservation and Recycling*.
- Romero Güiza, Maycoll Stiven, Joan Mata Alvarez, Josep María Chimenos Rivera, and Sergi Astals Garcia. 2016. "Nutrient Recovery Technologies for Anaerobic Digestion Systems: An Overview." *Revista ION*.
- Samco. 2021. "How Much Does Ion Exchange Cost?" [www.samcotech.com/how-much-ion-exchange-system-cost/](http://www.samcotech.com/how-much-ion-exchange-system-cost/).
- Sanders, J. P. M., and J. H. Kasteren. 2010. *InnovatieNetwerk Mest Als Waardevolle Grondstof: Enkele Technologische Opties*. <https://edepot.wur.nl/138781>.
- Schoumans, O.F. et al. 2017. *Chemical Phosphorus Recovery from Animal Manure and Digestate*. [www.wur.eu/environmental-research](http://www.wur.eu/environmental-research) (January 9, 2018).
- Schröder, J. et al. 2009. *Mestscheiding: Relaties Tussen Techniek, Kosten, Milieu En Landbouwkundige Waarde, Rapport 287*. Wageningen. <http://edepot.wur.nl/50884> (July 26, 2017).
- Shi, Lin et al. 2018. "Nutrient Recovery from Digestate of Anaerobic Digestion of Livestock Manure: A Review." *Current Pollution Reports* 4(2): 74–83.
- Sievers, D. M., M. W. Jenner, and M. Hanna. 1994. "Treatment of Dilute Manure Wastewaters by Chemical Coagulation." *Transactions of the American Society of Agricultural Engineers*.
- Smit, C T, H Prins, and Hoop. 2000. Den Haag: LEI, 2000 56 p ISBN 9052425876 (Rapport / Landbouw-Economisch Instituut ; 2.00.05) *Quick Scan Naar Afzetperspectieven van Mest En Mestproducten*.
- STIM, and VCM. 2004. *Mestverwerking Op Het Landbouwbedrijf: Mogelijkheden En Kostprijen*. <http://www.vcm-mestverwerking.be/publicationfiles/N-IV-MESTVERWERKINGOPHETLANDBOUWBEDRIJF1.pdf> (August 1, 2017).

- SYSTEMIC, Ivona Sigurnjak, Ludwig Hermann, and Emilie Snauwaert. 2018. *SYSTEMIC Fact Sheet Ammonium Sulphate*.
- Vaneekhaute, Céline. 2015. "Nutrient Recovery from Bio-Digestion Waste: From Field Experimentation to Model-Based Optimization."
- . 2017. "Nutrient Recovery from Digestate: Systematic Technology Review and Product Classification." *Waste and Biomass Valorization* 8(1): 21–40.
- VCM. 2018a. "Communication with Demo Plants SYSTEMIC."
- . 2018b. "Communication with Outreach Location or Associated Plant SYSTEMIC."
- Velthof, G. 2011. "Kunstmestvervangers Onderzocht: Tussentijds Rapport van Het Onderzoek in Het Kader van de Pilot Mineralenconcentraten." <http://edepot.wur.nl/163145> (August 4, 2017).
- Veltman, Alex. 2012. "Pilotonderzoek Op de Rioolwaterzuivering Amsterdam West, Struviet Productie Door Middel van Het Airprex Proces." : 46.
- Verdoes, N. 2013. "Mestbewerking En Mestproducten." *De waarde van mest*.
- VITO. 2010. "Coagulation-Flocculation." WASS. <https://emis.vito.be/en/bat/tools-overview/sheets/coagulation-and-flocculation> (November 9, 2020).
- VLM. 2018. *Agronomische Waarde van Bewerkte Dierlijke Mest Valoriseren En Optimaliseren - Luik 1*.
- de Vogeleer, Gerlinde. 2009. "Technologieverkenning Industriële Droogtechnieken." : 132.
- Vondra, Marek, Vítězslav Máša, and Petr Bobák. 2017. "The Energy Performance of Vacuum Evaporators for Liquid Digestate Treatment in Biogas Plants." *Energy*. <http://cyber.sci-hub.tw/MTAuMTAxNi9qLmVuZlZlZjEzNQ==/10.1016%40j.energy.2017.06.135.pdf> (September 12, 2018).
- Waeger, F., T. Delhaye, and W. Fuchs. 2010. "The Use of Ceramic Microfiltration and Ultrafiltration Membranes for Particle Removal from Anaerobic Digester Effluents." *Separation and Purification Technology*.
- Zhang, K., and K. Farahbakhsh. 2007. "Removal of Native Coliphages and Coliform Bacteria from Municipal Wastewater by Various Wastewater Treatment Processes: Implications to Water Reuse." *Water Research*.



Systemic large-scale eco-innovation to advance circular economy and mineral recovery from organic waste in Europe

### Consortium

Wageningen University and Research (NL)  
AM Power (BE)  
Groot Zevert Vergisting B.V. (NL)  
Acqua & Sole S.r.l. (IT)  
RIKA Biofuels Development Ltd. (UK)  
GNS Gesellschaft für Nachhaltige Stoffnutzung mbH (DE)  
A-Farmers Ltd (FI)  
ICL Europe (NL)  
Nijhuis Water Technology (NL)  
Proman Management GmbH (AU)  
Ghent University (BE)  
Milano University (IT)  
Vlaams Coördinatiecentrum Mestverwerking (BE)  
European Biogas Association (BE)  
Rural Investment Support for Europe (BE)

### Project coordinator

Oscar F. Schoumans  
Oscar.Schoumans@wur.nl  
Wageningen Environmental Research  
The Netherlands

Project website: [www.systemicproject.eu](http://www.systemicproject.eu)

The SYSTEMIC project has received funding from the European Union's Horizon 2020 Framework Programme for Research and Innovation under Grant Agreement no. 730400



Horizon 2020